

INDEX

ENGLISH.....

SPAVIDA

! ATTENTION

This instructions manual contains essential information regarding safety measures to be taken during installation and start-up. Both the installer and the user must therefore carefully read these instructions before assembly and start-up.

CONTENT

1. INTRODUCTION	7
2. PRECAUTIONS AND PREVENTIVE MEASURES	7
3. INSTALLATION	8
3.1. Safety notes.....	8
3.2. Hot tub location and installation	9
3.3. Description of the installation	12
3.4. Electrical connections.....	14
4. START-UP	20
5. INSTRUCTIONS FOR USE	21
5.1. Precautions	21
5.2. Commands.....	24
5.3. Filling.....	24
5.4. Draining.....	25
5.5. Level sensors	26
5.6. Filtration.....	27
5.7. Smart winter mode (SWM).....	28
5.8. Massage	28
5.9. Water temperature control	28
5.10. ECONO mode	29
5.11. Chromotherapy.....	29
6. MAINTENANCE	30
6.1. Notes on maintenance work	30
6.2. Acrylic care.....	30
6.3. Maintenance in periods of non-use and absence	31
6.4. Water maintenance	32
6.5. Filter maintenance.....	36
6.6. Spotlight maintenance	36
7. ERROR CODES	37
8. TROUBLESHOOTING	38
9. RECYCLING AND THE ENVIRONMENT	38
10. EVIDENCE OF CONFORMITY	39

1. INTRODUCTION

This manual contains all the information required to fully enjoy your HOT TUB. It is essential that you carefully read the points detailed below.

A hot tub is specially designed for bathing, offering a combination of bathing and massage. It consists of a pump-driven closed water loop that produces a relaxing massage on a person's body.

For effective bathing and massaging, the temperature of the water in the loop must be between 34°C and 37°C. This is achieved using an electric heat exchanger or an external heater when it is filled.

If you have any questions or queries about the operation or maintenance of this product, contact your local installer or dealer. They are specialized professionals whose knowledge will help to make it easier for you to fully enjoy this product.

IMPORTANT: The manufacturer reserves the right to change part of the designs or specifications without prior notice or any liability on its part.

2. PRECAUTIONS AND PREVENTIVE MEASURES

- Take great care to prevent children from entering the hot tub without permission. To avoid accidents, make sure that children are always being supervised by an adult. Take care when entering and leaving the hot tub to prevent any slipping caused by wet or damp surfaces.
- You must follow the current accident prevention regulations.
- Do not allow anyone to play with metal or sharp objects inside the hot tub, they may damage the acrylic surface.
- You must prevent bathers from accessing the hot tub's electrical parts.
- Do not use electrical devices such as radios, hair dryers, etc. inside the hot tub.
- Always maintain the minimum water level shown on the filter (even if the level sensors are not working).
- If using a cover that does not include any fastening and/or safety elements to prevent uncontrolled access to the hot tub, we recommend installing an alternative element (e.g.: restrict access to the area or a perimeter fence, etc.) to prevent any access to/improper use of the hot tub.

3. INSTALLATION

3.1. Safety notes

- A qualified professional should install, start up and perform maintenance on the system, closely following the installation instructions and all instructions that appear in this manual.
- This system cannot be connected to a domestic power line. Make sure that the characteristics of the electrical installation meet the following requirements: **3 phases, 400 V phase to phase and 230 V phase to neutral.**
- It is compulsory to comply with all the applicable electrical safety regulations of the country in which the system is installed.
- The safety of people and materials must be ensured. You must comply with the established safety regulations and codes.
- The system's electrical input must always be protected by a highly sensitive 30 mA residual current device (RCD).
- Only use a high-quality connection, with a suitable cable cross-sectional area and proper earthing.
- Make sure that the thermal magnetic circuit breakers have been calibrated according to energy consumption (amperage).
- Do not use the electrical cabinet to connect other devices.
- The maximum values that appear on the electrical panel must never be exceeded.
- It is not permitted to make any modifications without the manufacturer's express consent.
- Only use original spare parts supplied by the manufacturer.
- Some parts of the equipment operate at a very dangerous high voltage. Do not handle them unless the system is fully disconnected from the power supply or if the start-up devices are not locked out.
- The maximum values that appear on the power distribution board must never exceed the recommended amperage.
- Check the cables and hydraulic devices before starting the system or connecting it to the mains supply.
- Make sure that no electrical component is in contact with the water.
- Do not handle the equipment with wet feet.
- The manufacturer will not be liable for any damage caused by installing unauthorized accessories or any damage caused by improper handling by unqualified persons. Contact your authorized dealer or technical support service if you have any questions or require technical assistance.

! ATTENTION

A proper earth connection is essential. The building's earth circuit must always be in a perfect condition to guarantee the safety of the hot tub user. If in doubt, get a suitably qualified person to check your earth circuit. The manufacturer will not be liable for any injury or damage caused by inadequate maintenance of the earth circuit.

3.2. Hot tub location and installation

Before proceeding with the installation and assembly of the hot tub, you must ensure that you have received your product with the packaging in perfect condition. If the packaging is damaged, notify your dealer immediately.

The hot tub must be handled very carefully and cautiously by several people at once. Never hold the hot tub by its pipes.

The hot tub should be installed according to the following criteria:

- You should not place any items that are not fully moisture- and water-resistant either beneath or around the hot tub (within a one-meter perimeter). The hot tub's warranty does not cover any damage to ornamental or decorative materials or items that may have been caused by flooding or air humidity.
- The base on which the hot tub is installed must be large enough to bear the weight of the hot tub, its water, and the maximum number of users. Otherwise, the warranty will not cover any damage that may occur. See the current building regulations.
- Place the hot tub in a horizontal position, resting the whole lower base on an even, flat surface that can bear its weight when in use (full of water, plus the weight of the bathers). Do not install it on a curved surface or on top of blocks that concentrate the weight at specific points.



1

- A suitably sized drain must be provided to allow the full volume of water to drain away.
- Prior to installation, if you believe that there is any reason why you may have to remove the hot tub from its initial location, you should take this into account to avoid any future damage to the building or pipework if it is dismantled. The warranty does not cover repairs of such damage.

- The sides where the motors and thermostatic valve are located must always be fully accessible to allow maintenance work to be performed. The location of the hot tub must allow it to be moved so that all sides can be easily accessed.

OUTDOOR INSTALLATION

If you choose to place the hot tub **outdoors**, note the following points:

Do not leave the hot tub exposed to the sun without water and without a protective cover. Prolonged exposure to the sun may damage the surface of your hot tub and its accessories. Acrylic quickly absorbs heat from the sun's rays, and it may reach very high temperatures that would damage it. The maximum temperature that it can withstand is 60°C.



2

If possible, the hot tub should be placed away from areas with trees, to prevent any falling leaves from clogging the filter and water loops.

When placing the hot tub in glazed areas, avoid direct sunlight on the hot tub through the windows, as this may excessively increase the temperature.

When leaving the hot tub **outdoors at temperatures close to 0°C**, there are 2 options:

- For frequent use, leave the water in the hot tub, insulating the water supply pipes to prevent them from freezing. The hot tub has a mode that prevents the water from freezing inside it by recirculating it through the heat exchanger when the water's temperature falls below 7°C (see section 5.7. Smart winter mode).
- If it is not going to be used, the hot tub should be fully drained and the water supply's threaded fittings should be removed, ensuring that there is no water left inside the hot tub or in the pipes. (See section 6.3. Maintenance in periods of non-use and absence).

INDOOR INSTALLATION

It is advisable to provide some drainage in the vicinity of the hot tub, to prevent water from accumulating around it and avoid slippery areas where it is entered by bathers.

Remember that operating the hot tub increases the humidity in the room in which it is located. Therefore, it is advisable to have a ventilation system to prevent any build-up of humidity that may damage nearby elements.

Using the cover reduces heat loss and the humidity in the area.

! ATTENTION

Do not leave the hot tub empty and uncovered at temperatures above 20°C or below 4°C.

IN-GROUND VERSION

The hot tub's frame should never be fixed to the ground. The hot tub contracts and expands due to temperature changes. Fixing the hot tub to the ground may cause irreparable damage and cracks in the acrylic shell. It should simply be put in place and settle under its own weight in the desired location. Do not lift or handle the hot tub by its upper edge.

When the hot tub is properly seated in position, finish the works, bearing in mind that you must leave a clearance of at least 400 mm around the shell for possible maintenance. Never place any items there that could touch the hot tub's shell, pipes or accessories. Leave an access hatch or way to access the area around the hot tub for maintenance work. This area should be at least 700 mm.

You can finish the work with tiles or similar, ensuring that the area around the hot tub's shell never comes into direct contact with anything that you install (you should leave at least 1 centimetre all around it).

To seal the hot tub's rim, use a special elastic sealant for water installations.

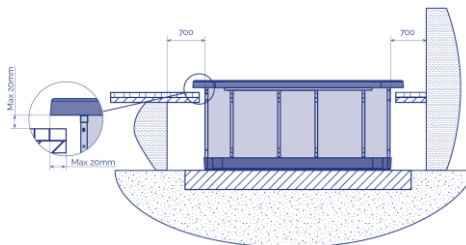

Never fill the hot tub's upper profile with cement or any other material that expands/contracts differently to the shell. This would lead to the hot tub cracking. Never concrete over the hot tub's pipes or accessories.

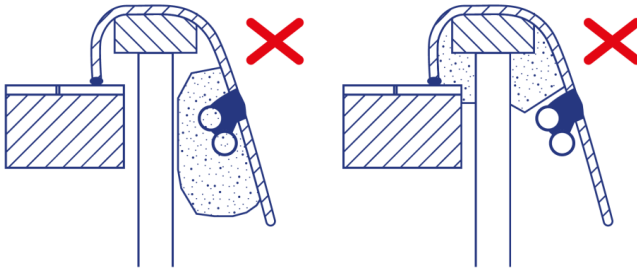

4

3.3. Description of the installation

When the hot tub is installed in a suitable location, the hot and cold water outlets need to be installed for automatic filling. A water seal (siphon) also needs to be installed in the drain area.

WATER SUPPLY

1. Carefully remove the hot tub's left panel (position yourself in front of the three flat cushions).

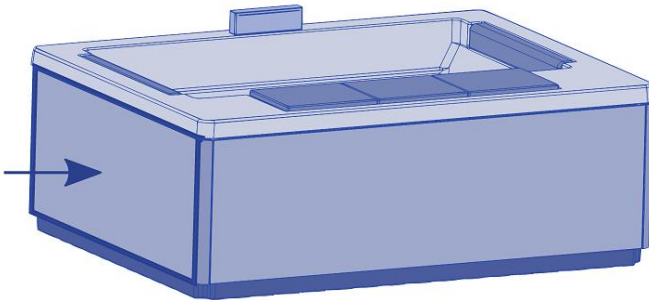

5

2. Connect the two water supply pipes with a G 3/8" male thread (see the image below). Connect the hot water outlet with the ball valve to the butterfly valve and the cold water outlet to the blue one.

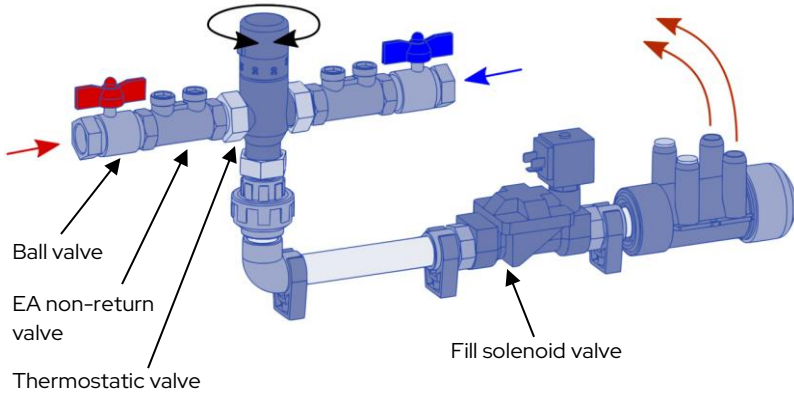

6

When this is done, the thermostatic valve receives cold water from the drinking water supply and hot water from the domestic hot water (DHW) system where the hot tub is located. This makes it possible to set the desired temperature at which the hot tub is filled via the waterfall (orange arrows).

To adjust the water temperature, see section 4. Start-up.

WATER SEAL (SIPHON)

It is necessary to install a water seal, just behind the thermostatic valve. This prevents bad smells from passing into the area where the hot tub is located. It must have the required characteristics and comply with the wastewater regulations in each country.

It must be installed at the outlet of the hot tub's drain loop (as shown in the image below) and connected to the building's sewage system, into which all the water will be drained.

The water seal must be connected via a plain-ended PVC pipe that is 50 mm in diameter.

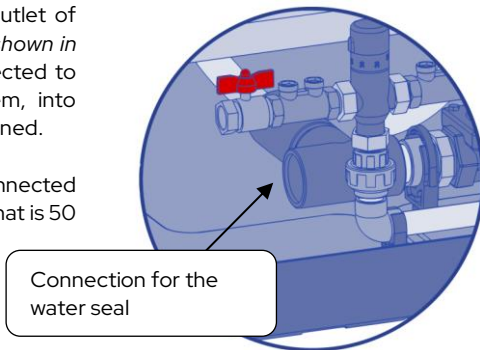

7

! ATTENTION

The water seal (siphon) is not supplied with the hot tub.

3.4. Electrical connections

! ATTENTION

- This system cannot be connected to a simple plug.
- It requires a suitable electrical installation. This should be done by a qualified person, following the electrical safety regulations applicable in each country.
- The hot tub's power supply must always be protected by a highly sensitive residual-current device. We recommend a 30mA residual-current device.
- A suitable earth connection must be made.
- Use a cable with a cross-sectional area that is suitable for the hot tub's power and the distance to the electrical panel.
- Always follow the instructions and heed the warnings in this manual.

! ATTENTION – RISK OF ELECTRIC SHOCK

- Before performing any work on the hot tub, you must disconnect the power supply (*residual-current device in OFF position or disconnect the cable from the mains*).
- Do not attempt to access any electrical component if you are not technically qualified.
- When handling electrical components, always use personal protective equipment and suitable tools.
- Never access the electrical components if you have a wet body or feet.

STEPS FOR CONNECTING THE HOT TUB

1. Localice el panel de control eléctrico, abra el panel lateral del mueble que da acceso a los componentes eléctricos.
2. Abra el armario de maniobra y conecte el cuadro eléctrico del Spa al diferencial.

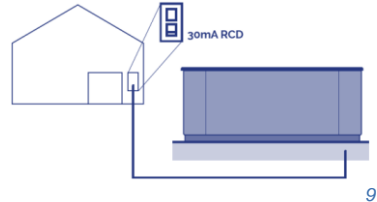
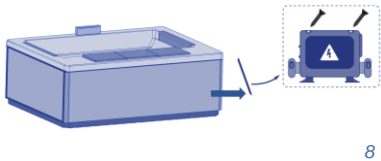

⚠ IMPORTANT

Before making the electrical connections, you must check the water fittings for cold water, hot water, and the drain with its corresponding siphon.

INSTALLING THE RESIDUAL-CURRENT DEVICE



The electrical installation must include a highly sensitive double-pole residual-current device on the main electrical panel (*the residual-current device is not supplied with the hot tub*).

⚠ IMPORTANT

It is essential for the owner of the hot tub to test and turn the residual-current device on/off regularly to make sure that it is working correctly. We recommend doing this at least once a month.

CONNECTING THE HOT TUB'S ELECTRICAL PANEL TO THE RESIDUAL-CURRENT DEVICE

You must disconnect the power supply before performing any work on the hot tub (residual-current device in OFF position or disconnect the cable from the mains).

Depending on the type of setting in which the hot tub is being installed and the current applicable legislation, a cable with a suitable cross-sectional area must be used to connect the residual-current device to the hot tub's electrical panel. The cable's cross-sectional area will vary depending on the hot tub model and the distances within the installation.

CABLE CROSS-SECTIONAL AREAS

Use cables with suitable cross-sectional areas (as per the table below) to ensure proper operation and avoid potential electrical problems that may jeopardise the user's safety.

Distance	KW required										
	2,1	2,5	2,8	3,2	3,5	4,4	5,3	6,2	7	7,9	8,8
	Nominal section of the cable in mm ²										
6 – 11 m	2,5	2,5	2,5	2,5	4	4	6	10	10	10	10
11 – 15 m	2,5	2,5	4	4	4	6	6	10	10	10	10
15 – 20 m	4	4	4	6	6	6	10	10	10	16	16

The cable's cross-sectional area will have to be increased proportionally for greater distances.

There may be configurations that require the installation of a 32 A line, two 16 A lines or even a three-phase line (3 x 16 A) to meet the hot tub's power requirements.

The layout options for your electrical panel are shown later in this Installation manual.

Remember that installation and changes to the electrical layout must be performed by duly qualified persons and always comply with the current regulations in each country.

The manufacturer accepts no liability for any damage that may be caused by an installation that is inadequate or performed by someone who is unqualified.

IMPORTANT

Note the position of the maximum current DIP switch. If the cable that is used is unsuitable for the hot tub's distance and power, it will not work properly; this may lead to the electrical circuits overheating, with the resulting risk of an electrical accident. Always use a cable with a cross-sectional area that is suitable for the maximum current. **If in doubt between two sizes, always use the cable with the largest cross-sectional area.**

To supply power to the hot tub's electrical panel, locate the cable gland on one side of the electrical panel.

It is necessary to install a thermal magnetic breaker and a residual-current device (*not supplied*) at the connection to the power supply.

Make sure that no power is being supplied to the connection cable (*residual-current device in the OFF position*).

Feed the cable to the hot tub's electrical panel.

Open the electrical panel's cover and insert the power cable into the free side.

Attention, the blue cable is the neutral wire (BLU) and the brown (BRN) one is the line or phase wire.

Attach the connectors as shown in the diagrams below, according to the type of power supply.

230 V SINGLE-PHASE LINE

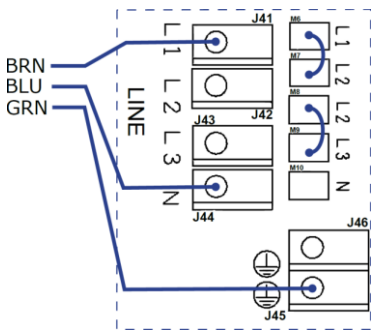

11

380 V THREE-PHASE LINE

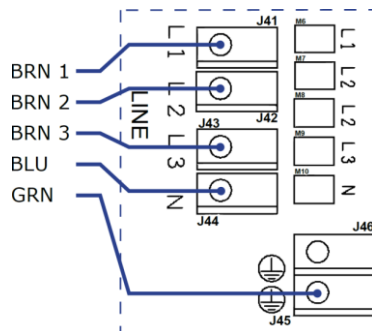

12

Power requirements:

- 50/60 Hz
- 1 x 16 A line at 230 V

Power requirements:

- 50/60 Hz
- 3 x 16 A lines at 380 V (circuit breaker power = 20 A max. each line)

In the three-phase line, the M6-M7 and M8-M9 jumpers must be removed.













! ATTENTION

A proper earth connection must be made.

The building's earth circuit must always be in a perfect condition to guarantee the safety of the hot tub user.

If in doubt, get a suitably qualified person to check your earth circuit. The manufacturer will not be liable for any injury or damage caused by inadequate maintenance of the earth circuit.

PRINTED CIRCUIT BOARD

Connectors	Terminal	Description
	Pump1 (J23)	Massage pump
	Heater (J48)	Heater
	Ozone (J27)	Drain solenoid valve
	CP (J28)	UV/Ozone power and filtration pump
	EV.FULL (J26)	Fill solenoid valve
	TEMP PRB (J32)	Heater temperature probe*
	L1 (J21)	Minimum level sensor
	L2 (J22)	Maximum level sensor
	SPOT 12Vac (J20)	Spotlights
	DEVICE (M1, M2)	Control panel (KAP.KI)
	AUX (M8)	Light transformer
	J41, J42, J43, J44	Single-phase/three-phase power line
	J29, J30, J45, J46	Earth connection
		Connectors connected to the safety board

*The temperature probe is connected to the J32 connector on the motherboard and to the safety board, which is connected to the motherboard's faston terminals perpendicular to this board.

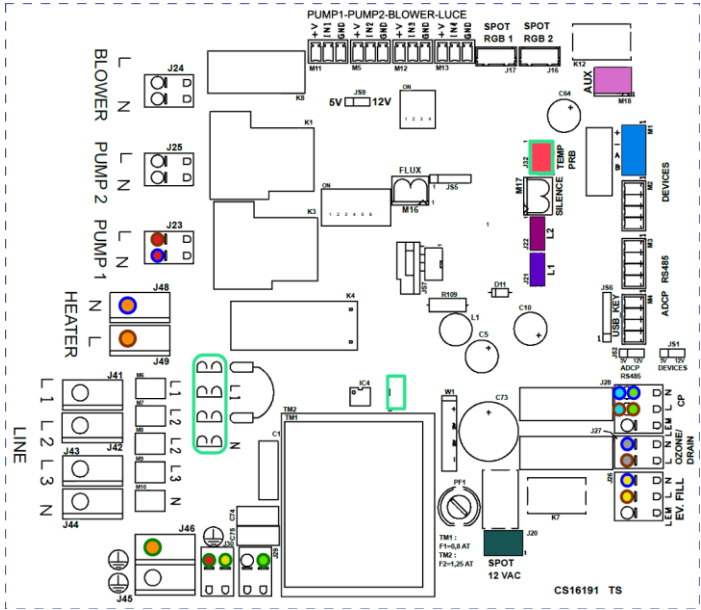

13

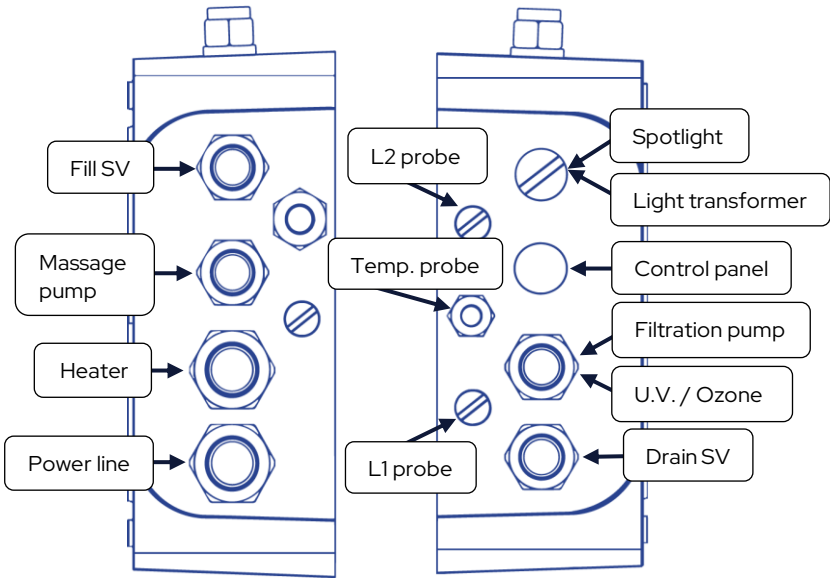

14

The electrical panel's controllers have been configured to fulfil the installed functions using the board's DIP switches. The manufacture accepts no liability for the user operating these switches as this may result in the hot tub not working correctly.

! ATTENTION

Make sure that all water fittings and electrical/electronic connectors are connected before connecting the electrical cabinet to the power supply.

Cable glands must be used on all connectors from the control cabinet and from the junction box. Terminals must be used on all connections to maintain the integrity of the cables.

4. START-UP

With the main residual-current device in the OFF position, clean the hot tub's shell to prevent any particles from the installation work being absorbed into the components/loops or clogging them.

Then, switch the residual-current device into the ON position, open the stopcocks and, on the control panel, start filling by holding down  for 3 seconds. This opens the fill solenoid valve.

Adjust the thermostatic valve to set the desired inlet water temperature. There follows an illustrative table for proper operation.

Knob position	0,5	1	2	3
Temperature (°C)	20	28	37	42

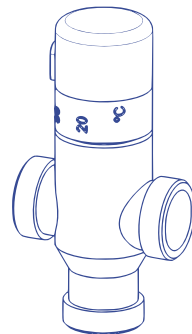



15

If the cold water inlet temperature is not the same, or you want a temperature in the hot tub that is different to those in the table, you may have to change the position slightly as appropriate.

We recommend checking the outlet temperature regularly to ensure that it is optimal and adjusting it when necessary.

When the minimum water level has been reached, check for leaks of any kind and, if there are none, turn on the filtration pump to expel the air inside the loop and fill it with water. To do this, see section 5.6. Filtration by setting the activation time to 0 so that it comes on immediately. Then, follow the instructions in that section to set the desired filtration intervals.

It is not possible to start any loop until the minimum water level is reached (L1 sensor), so all functions on the control panel are disabled besides the spotlights 

As with filtration, it is possible to turn on the massage system in order to fill the water loop. To do this, press .

We recommend inspecting all connections to check for any leaks after turning on the loops and rechecking after 30 minutes of operation.

After performing these checks, complete the Warranty form that comes with the product and return it to the manufacturer.

To adjust the jet flow rate and open/close the flow of water, proceed as follows:

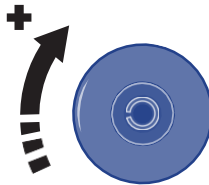

16

5. INSTRUCTIONS FOR USE

5.1. Precautions

SAFETY NOTES

- Check the water temperature regularly. Do not use water at temperatures above 40°C. The ideal temperature is 35-36°C.
- Set the hot tub to a lower temperature if you are going to use the hot tub for more than 10-15 minutes.

- Pregnant women, small children, people with heart conditions, health problems or who are under medical supervision should not use the hot tub without checking with their doctor first.
- Take special care if you are alone when using the hot tub. Prolonged soaking in hot water can cause nausea, dizziness, and fainting.
- Do not use the hot tub after drinking alcohol or taking drugs or medication that cause drowsiness or may raise/lower blood pressure.
- Take special care when getting in and out of the hot tub. Wet surfaces increase the risk of falls.
- You should not use electrical or electronic devices (radios, hair dryers, etc.) inside or near to the hot tub.
- While you are using the hot tub, keep your head, body and clothing at least 40 cm away from the suction outlets. If you have long hair, you should tie it up and fix it in place.
- Only use original spare parts. Any modification to the product will require the express authorization of the manufacturer.
- Check the level of chlorine and the water's pH level before using the hot tub. Avoid using the hot tub if these levels are outside the normal recommended ranges or if a shock treatment is underway.

PRECAUTIONS FOR USE

- In the event of a power outage, make sure that the water loop is prepared or connect/disconnect the necessary elements before restoring the power.
- This device can be used by children above the age of 8 and by persons with physical, sensory or mental impairment or a lack of experience or knowledge, provided that they are being supervised by an adult.
- Do not allow children to play with the device.
- Take great care to prevent children from entering the hot tub without permission. To avoid accidents, make sure that children are always being supervised by an adult. Do not leave children alone in the hot tub. Take care when entering and leaving the hot tub to prevent any falls caused by wet or damp surfaces.
- Do not allow anyone to play with metal or sharp objects inside the hot tub, they may damage the acrylic surface.
- Prevent bathers from accessing the hot tub's electrical parts.
- Do not use electrical or electronic devices inside the hot tub.
- Do not place animals in the hot tub.
- Do not fill the hot tub with any fluid other than drinking water.
- Avoid using the hot tub immediately after performing strenuous physical exercise.
- Do not use the hot tub if you have a contagious disease or within 14 days of having a contagious disease.

- All our hot tubs are designed so that their pumps draw the water through anti-vortex drain covers located at the bottom of the hot tub. Take special care to prevent these drains from being covered or blocked by an object or by the bathers themselves (pieces of clothing, hair, lower limbs, etc.). For your safety, always keep your head outside the hot tub to prevent drowning or accidental entrapment. Do not use the hot tub if the drains are broken, damaged or removed because, besides damaging your hot tub, you run the risk of drowning or entrapment.
- The headrests on your hot tub are made of synthetic foam that may be degraded by high concentrations of bromine/chlorine or low pH levels. When adding chemicals make sure that the headrests are not fully or partially submerged in the water. If necessary, remove the headrest until the chemical levels have stabilised. Any damage caused by incorrect use will not be covered by the product's warranty.
- The hot tub is supplied with a cover that is designed to protect its acrylic surface from sunlight when your hot tub is not in use. This cover will also help you to maintain the hot tub's water temperature. However, it is not designed to bear any weight. Not even water or snow. Avoid placing objects on top of the cover. Do not allow people or animals to climb onto the cover. Remove the snow regularly to prevent any build up.
- The device is powered through a residual-current device (RCD) with a rated residual current no greater than 30 mA.
- It is necessary to check the condition of the water and disinfect it properly when using your hot tub, especially if it has remained unused for a prolonged period, whether with or without water inside. During periods of non-use, small amounts of standing water may remain in the hot tub, which can lead to the growth of microorganisms that are potentially hazardous to your health. Therefore, disinfect your hot tub as instructed in this manual, to ensure suitable pH and disinfectant levels.

PREVENTING THE RISK OF HYPERTHERMIA





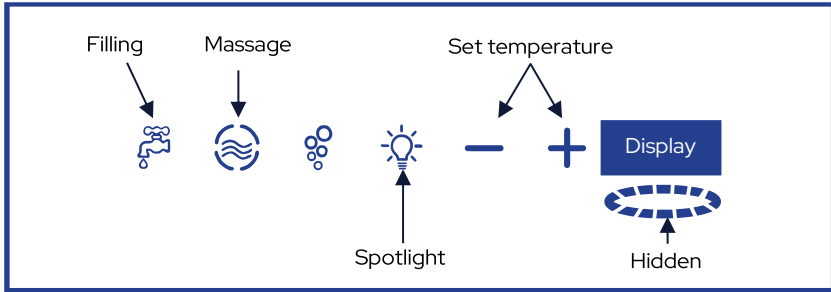

- Extended periods in direct contact with hot water can lead to HYPERTHERMIA, which occurs when the body's internal temperature rises above the normal temperature of 36,5°C. It is not advisable to continue bathing for more than 15 minutes.
- The symptoms of hyperthermia are a sudden drop in blood pressure and a resulting feeling of dizziness with the possibility of fainting.
- The water in the hot tub should never exceed 40°C.
- Water temperatures between 37°C and 40°C are considered safe for adults without health problems. Lower temperatures are recommended for most people and for children.

5.2. Commands





The functions and way to execute each control panel command are described below.



17

Function	Control
Massage 	1 st press: On → steady blue light 2 nd press: Off → white light
Filling 	 for 3 s
Draining	"Hidden button" for 3 s followed by 
Chromotherapy (spotlights) 	Pressed once: starts the colour sequence Repeated presses: changes the sequence.
	Pressed once for 3 s: Off

Special functions:

Function	Control
ECONO mode	 followed by  for 3 s
Demo cycle	"Hidden button" followed by  for 3 s
Establish filtration cycle parameters	"Hidden button" followed by  for 3 s

5.3. Filling

The fill solenoid valve, which is activated on the control panel by holding down  for 3 seconds, allows the water, which has already been mixed at the desired temperature, to flow into the hot tub. Filling takes place through the waterfall.

When filling of the hot tub begins, the message “L1” is displayed on the control panel, alternating with the water temperature, until water is detected for 3 seconds. Then, the panel displays “L2” while filling continues until it reaches the maximum level sensor (L2) for 10 consecutive seconds.

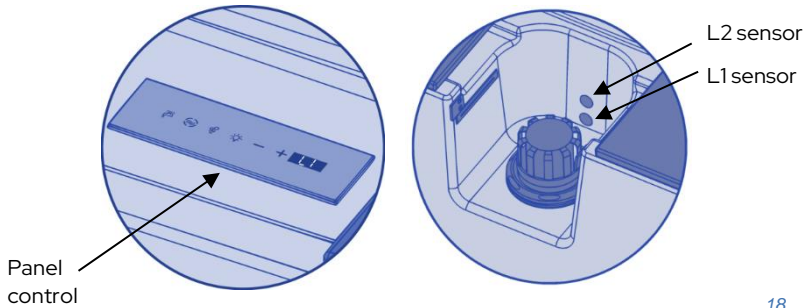

18

If the L1 and L2 sensors both detect water, the filling function is disabled.

See section 6.4. Water maintenance to see the specifications that should be considered regarding the water's characteristics.

5.4. Draining

The drain loop consists of two drains that are connected internally in front of the drain solenoid valve (SV). After the SV, the overflow loop is connected to the drain loop and, from there, to the drainage system via the water seal described above, which was installed by the installer.

When following a continuous water filling process, the hot tub has an overflow loop composed of 2 overflows that are located above the height of the telescopic filter. They discharge the excess water into the building's sewage system after it passes through the siphon, regardless of whether the SV is open.

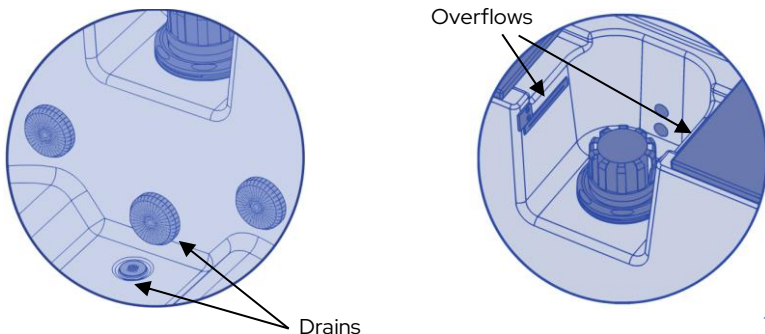

19

Follow the sequence described below on the control panel to drain the hot tub: "Hidden button" (hold down for 3 seconds) and then .

The water then flows through the drains at the bottom of the hot tub, towards the drain solenoid valve, which remains open for 60 minutes. Then from the SV to the drainage system.

If L1 continues to detect water for 3 seconds at the end of those 60 minutes, it keeps the solenoid valve open for a further 60 minutes. When it is finished,  lights up white.

The draining function can be stopped manually at any time by holding down  again for 3 seconds.

When this mode is activated, the massage pump is disabled.

! ATTENTION

Remember that draining the hot tub does not empty it completely.

For long periods of non-use, especially in the winter, remove the standing water on the seats and at the bottom of the hot tub with a sponge. Residual water in the pipes can be suctioned out via the water and air nozzles with a suction pump for liquids. The pumps must be drained through the drain plug.

5.5. Level sensors

The level sensors prevent functions from being activated when there is no water. This does not affect the functionality of the  function.

Level L1 is considered safe provided that the sensor detects water for at least 3 consecutive seconds. If water is not detected for that length of time, it remains off, thus activating the automatic filling procedure.

If the water level is below the L1 sensor, all the hot tub's functions are disabled and the message "LL" is displayed on the control panel. When a suitable water level is detected again, the functions are enabled again.

When the water reaches the maximum level sensor (L2) and continues to be detected for 10 consecutive seconds, it disables automatic filling. If the water level is below the L2 sensor, automatic filling is activated.

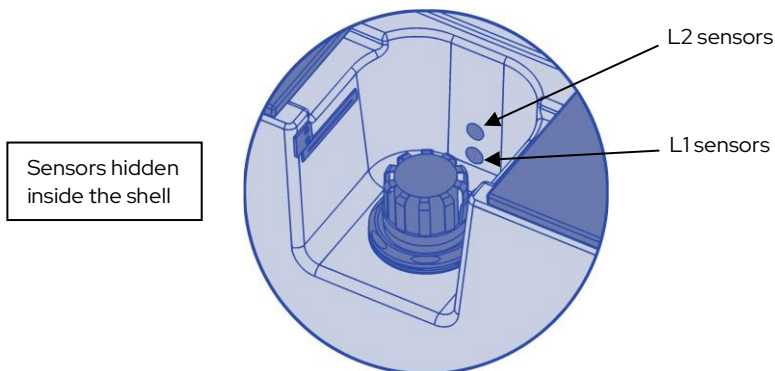

20

5.6. Filtration

This serves the function of filtering the water that is drawn through the filter. The water then flows through the disinfectant (ozone or U.V.) and is reheated without needing to be drained and refilled, thanks to the heat exchanger.

The filtration cycle has 2 stages:

1. The massage pumps are turned on for 1 minute.
2. The filtration pump is turned on for the set period.

When the filtration cycle is active, "FLt" is displayed on the control panel, alternating with the water temperature.



Filtration is stopped if another function is activated, and it resumes 5 minutes after the other function has been disabled.

The **filtration cycle** is programmed by setting the duration and the activation time parameters as follows:

- **Duration:** from 0 - 12 h, in 1-hour increments, so 0 disables the function and 12 = continuous filtration. By default, it is set at 0 hours (disabled).
- **Activation time:** enter the number of hours of delay before the function is required to start. Selectable values from 0 (filtration starts immediately) to 12 hours, in 1-hour increments. By default = 2 hours.

Once programmed, the cycles start every 12 hours, for the time entered with the buttons, i.e., 2 filtration cycles per day, one every 12 hours, from the moment it is first activated.

Configuration procedure:

- Select "Hidden button" then hold down  for 3 seconds. The control panel will display the cycle's duration as **dx** (where x is the duration in hours).
- Select the duration with the **-/+** buttons within 5 seconds.
- Confirm the selected value with . Once confirmed, the new value is saved and the next parameter is displayed.
- The control panel shows the delay until start-up as **sy** (where y is the delay expressed in hours)
- Select the value with the **-/+** buttons within 5 seconds.
- Confirm and save the new start-up time by simply pressing the  button.

The controller leaves parameter setting mode if the keypad remains inactive for more than 5 seconds.

After a restart (power on), filtration will begin after the delay selected with the sy parameter.

5.7. Smart winter mode (SWM)

With this function installed, the functions (massage and filtration) are activated regularly to prevent the water-carrying parts from freezing. This function starts automatically if the temperature detected by the water probe is $\leq 7^{\circ}\text{C}$.

If smart winter mode is activated, filtration is stopped and then resumed 1 minute after SWM ends.

Activation of functions: The massage pump is activated for 1 minute. If it is not yet running, the filtration pump is activated while the other functions remain activated.

The message "ICE" appears on the screen while this function is underway. If smart winter mode is activated, this system will not allow any other function to be enabled. However, if there is an active function, this mode will be disabled and, if it is still required, it will start 15 minutes after the active function is disabled.

5.8. Massage



This has an ON/OFF control. When you press the  button the massage pump comes on (lit in blue) and if you press it again it is turned off (lit in white).



5.9. Water temperature control

Every 30 minutes, the filtration pump is activated for 30 seconds to read the

temperature, even if the heat exchanger has not been activated. This serves to circulate the water from the heat exchanger, as the water inside this cool faster, which would lead to a lower-than-actual temperature reading.

SELECTING THE TEMPERATURE





The first time either  /  button is pressed, the control panel displays the current set temperature and both buttons light up blue; every time you press the buttons after that, the value will increase or decrease accordingly.

If the  /  buttons are not pressed for 6 seconds, or a different button is pressed, the screen shows the temperature again and both buttons light up white again. The new set temperature is now saved. The characteristics of this parameter are as follows:

- Temperature range: 15 - 40°C
- Increments of 1°C
- Default value 35°C
- Value at start-up: the system keeps the last set temperature value saved.

5.10. ECONO mode

With the ECONO function, energy can be saved by keeping the hot tub's water at 10°C below the temperature set by the user. In any event, the minimum permitted water temperature is 15°C. The user can control this function with the ECONO button, using a combination of controls on the keypad:

- Press the  /  buttons once to see the temperature that is currently set.
- Press and hold the  button for ≥ 3 s and the screen will display the new temperature that has been set, alternating with the "Eco" message for a few seconds. It will then show the current water temperature again.
- Press the  /  button once to confirm whether the function is active. If the function is active, the screen will display the set temperature, alternating with the "Eco" message; otherwise, it will only display the set temperature.
- To disable the function: the same procedure as above; the screen will display the set temperature.

5.11. Chromotherapy

When  is pressed once, the spotlights are turned on with the last selected sequence. If it is pressed again for less than 1 second, the sequence is changed.

To turn it off, simply hold down  for 3 seconds when it has been on for more than 1 second.

6. MAINTENANCE

Our hot tubs are made with the highest-quality and most durable materials available. Proper care and maintenance will ensure the long service life of your hot tub and its components.

6.1. Notes on maintenance work

- Before performing any electrical or mechanical maintenance work, make sure that the machine has been disconnected from the power supply and that the start-up devices have been not locked out.
- Do not handle the equipment with a wet body or feet.
- You must disconnect the power supply before performing any work on the hot tub (residual-current device in OFF position or disconnect the cable from the mains).
- This system cannot be connected to a simple plug.
- It requires a suitable electrical installation. This should be done by a qualified person, following the electrical safety regulations applicable in each country.
- The hot tub's power supply must always be protected by a highly sensitive residual-current device. We recommend a 30mA residual-current device.
- Earthing is essential. The building's earth circuit must always be in a perfect condition to guarantee the safety of the hot tub user. If in doubt, get a suitably qualified person to check your earth circuit. The manufacturer will not be liable for any injury and/or damage caused by inadequate maintenance of the earth circuit.
- Use a cable with a cross-sectional area that is suitable for the hot tub's power and the distance to the electrical panel.
- Always follow the instructions in chapter: 2. Precautions and preventive measures.
- Do not attempt to access any electrical component if you are not technically trained.
- Never access the electrical components if you have wet feet.
- The building's electrical system must have a mechanism to disconnect the hot tub from the mains supply, in accordance with the current regulations.

6.2. Acrylic care

Easy care for an attractive surface:

- Use common general purpose cleaners. For normal care and cleaning, use a soft cloth or sponge with a little soap and water. Rinse well and dry with a clean, dry cloth.
- Never use abrasive cleaners.
- Do not allow the acrylic surface to come into contact with ketones or esters such as acetone, acetates (such as nail varnish remover, nail varnish or dry cleaning substances) or any organic solvent with chlorine, varnishes, petrol, aromatic solvents, etc.
- Remove dust, mud and dry dirt with a soft damp cloth.

- Clean grease, oil, paint and ink stains with isopropyl alcohol and dry with a clean, dry cloth.
- Avoid using razors or any other type of sharp instrument that could scratch the surface. Small scratches can be removed by applying a thin layer of car paste wax and buffing it gently with a dry cloth.
- Once a week, clean the part of the hot tub that is not submerged in water with a high-quality polish for hot tubs.

! ATTENTION

Remember never to expose the hot tub to sunlight when it is uncovered and empty, as this may lead to damage that is not covered by the warranty.

6.3. Maintenance in periods of non-use and absence

SHORT PERIODS (3-5 DAYS)

- Adjust the pH and treat the water (see section 6.4. Water maintenance).
- Cover the hot tub.
- When you return, adjust the pH and treat the water again.

LONG PERIODS (5-14 DAYS)

- Set the temperature to its lowest level.
- Adjust the pH and treat the water (see section 6.4. Water maintenance).
- Cover the hot tub.
- When you return, reset the temperature to the desired level and adjust the pH and treat the water again.

PREPARING FOR THE WINTER

If you do not use the hot tub during the winter or for very long periods, you must perform the following operations:

- Disconnect the electrical equipment, residual-current device's switch in the OFF position.
- Close the stopcocks for the water supply to the hot tub.
- Drain the water from the hot tub and all of its pipes.
- Leave all of the loop's valves open, remove all of the pumps' drain plugs and disconnect the hot tub's water supply pipes, ensuring that they are completely empty.
- Clean and dry the hot tub.
- Cover the hot tub with the cover.

The hot tub should not be left outdoors with water inside and disconnected from the power at temperatures below 0°C. The water may freeze in the pipes and damage the hot tub.

 **IMPORTANT**

You must comply with the regulations in force in each country on controlling **Legionella**. All responsibility for compliance rests with the owner.

6.4. Water maintenance

Water maintenance is a point that requires the user's closest attention, due to its importance. This maintenance will depend on the mineral content of the water used, how often the hot tub is used and the number of people who use it.

There are three key points for water maintenance:

- Water filtration
- Chemical analysis and pH control
- Water disinfection

SAFE USE OF CHEMICALS

Before using any chemical, carefully read the instructions for use provided by the manufacturer on the product's label.

- We recommend that the same person always uses the chemicals.
- Keep these products out of reach of children.
- Add the exact specified amounts to the water. Neither too much nor too little.
- Keep containers closed, in dry and well-ventilated places.
- Do not inhale chemicals and do not allow them to contact with your eyes, nose or mouth. Wash your hands after using them.
- Follow the emergency instructions that appear on the product's label in the event of an accident or if ingested.
- Avoid smoking when handling these products. They may be flammable.
- Store these products in a suitable place, never inside the hot tub's cabinet.
- Do not mix the products together. Add them to the water one at a time. This avoids any unwanted chemical reactions between them.
- Do not pour chemicals into the water while there are people inside the hot tub.

MAINTENANCE PROGRAMME FOR YOUR HOT TUB'S WATER

Al chemicals: chlorine, bromine tablets, algaecides, calcium descales and pH reducer/increaser, etc.: must be poured into a floating dispenser (not supplied), with the massage pump running for at least ten minutes.

ADJUSTING THE PH

A pH value between 7.2 ppm and 7.6 ppm is recommended. PH level measures acidity and alkalinity. Values above 7 ppm are alkaline; below 7 ppm they are acidic.

! ATTENTION

It is extremely important to maintain a correct pH level, to ensure that the disinfectant works properly and to avoid any corrosion or scaling in the hot tub.

If the pH level is very low, it has the following effects:

- The disinfectant will dissipate quickly.
- The hot tub's equipment may begin to corrode.
- The water may start to cause irritation to bathers.

If the pH level is very high, it has the following effects:

- The disinfectant is less effective.
- Scaling will appear on the acrylic and on the equipment.
- The water may turn cloudy.
- The pores in the filter cartridge may become clogged.

Check the water's pH level daily with the pH test kit.

If the pH level is too high, use CTX pH MINUS for hot tubs. Wait for two hours before testing the pH level again. If the pH level is too low, use CTX pH PLUS for hot tubs. Wait for two hours before testing the pH level again.

When the pH level is within the above range, follow the instructions below.

WATER DISINFECTION

Disinfecting the water is vitally important to destroy algae, bacteria and organisms that can grow in the water. However, over-disinfecting can cause irritation to skin and eyes.

Bromine tablets are the most suitable water disinfectant for your hot tub. This product is placed in the pre-filter to gradually dissolve. Check the level of residual

bromine every day using the bromine test kit. We recommend **residual bromine levels between 2.2 and 3.3 ppm**. If using chlorine, to ensure that it is effective, you should maintain a **free residual chlorine concentration between 0.5 and 1.5 ppm**.

USING SPECIAL PRODUCTS

As well as products to maintain pH and disinfectant levels, there are other products that are specially formulated for use in hot tubs, which will help you to keep the water and equipment in a perfect condition.

- **CTX DESCALER FOR HOT TUBS:** Prevents build-ups of calcium salts (scaling), especially in hard water. This product is added weekly and every time that the water is changed.
- **CTX ALGASTOP FOR HOT TUBS:** This algacide prevents algae from growing in the hot tub's water. This product is added weekly and every time that the water is changed.
- **CTX ANTI-FOAM FOR HOT TUBS:** Due to the water being agitated and the oils present in the water, foam is often formed. When a substantial amount of foam is observed in the water, remove it with CTX Anti-Foam for hot tubs.
- **CTX WATERLINE CLEANER FOR HOT TUBS:** To eliminate the rings of dirt and grease that form on the hot tub's walls. To use this product, we recommend draining the water from the hot tub and applying the degreaser onto the areas being cleaned with a sponge. Then rinse with plenty of water.

OZONE GENERATOR (depending on the hot tub model's features)

Ozone, O₃, is an oxidising chemical compound that is very effective at disinfecting water. Its main benefits are that it leaves no chemical residues and it is odourless.

It works as a disinfectant thanks to its oxidation potential, which eliminates any organic matter that may be in the water.

To produce ozone, there is an ozonator which uses electricity to produce ozone ions from the oxygen in the air. This process occurs automatically and the resulting product is injected into the hot tub via the filter's return nozzles. No action is required on the user's part to produce the ozone.

The water is collected by the overflow, the drains or the skimmer, due to the suction of the filtration pump.

It then passes through the heat exchanger and the ozone is injected at its outlet. The water is distributed via the filter return line.

Ozone treatment can be used together with other chemicals such as bromine or chlorine. Ozone is considered a supplementary treatment to bromine or chlorine, making it possible to use smaller amounts of the latter.

U.V. DISINFECTION (depending on the hot tub model's features)

Ultraviolet rays (UV-C) allow water to be disinfected without using chemicals. When bacteria, viruses and protozoa are exposed to wavelengths between 200-300 nanometres (range C), these waves become a quick and effective germicide, preventing microorganisms from reproducing and contaminating the water.

Moreover, disinfection with UV-C rays is considered environmentally friendly, chemical-free, and highly effective at disinfecting the water and protecting it against harmful microorganisms. This disinfecting component is located after the filtration pump and before the electric heater. A lamp inside the unit emits UV-C rays that disinfect the water as it flows through it.

QUICK GUIDE TO USING CHEMICALS

	Reason for use	Quantity per m ³ of water	Frequency of use
pH minus hot tub	Add if the results of the pH test are above the permissible values (7.2-7.6 ppm).	Add as recommended by the manufacturer of the chemical.	Add pH daily with each pH test.
pH plus hot tub	Add if the results of the pH test are below the permissible values (7.2-7.6 ppm).	Add as recommended by the manufacturer of the chemical.	Add pH daily with each pH test.
Bromine tables	Add if the results of the Br test are above the permissible values (3-5 ppm).	Add as recommended by the manufacturer of the chemical.	Add Br daily with each test.
Descale	To prevent build-ups of calcium salts (scaling).	Add as recommended by the manufacturer of the chemical.	Weekly and every time that the water is changed.
Alga stop hot tub	To prevent algae from growing in the water.	Add as recommended by the manufacturer of the chemical.	Weekly and every time that the water is changed.
Waterline cleaner	To eliminate rings of dirt from the hot tub's walls.	Scrub with a sponge, and then rinse with plenty of water.	When dirt is seen on the walls of the hot tub.
Anti-Foam	Excess foam present in the water.	Add as recommended by the manufacturer of the chemical.	When foam appears in the water.

6.5. Filter maintenance

The condition of the filter cartridge should be checked regularly. If there is a build-up of dirt, it will have to be cleaned or replaced. Remember that a clogged filter causes a drop in the water flow rate, which may cause a fault in the hot tub. All hot tubs include a cartridge filter. Check the filter regularly and follow the maintenance instructions that appear below.

CLEANING THE TELESCOPIC FILTER

1. Disconnect the electrical equipment. Residual-current device in OFF position.
2. Unscrew the cap at the top of the filter.
3. Remove the cartridge.
4. Clean the cartridge with low-pressure water.

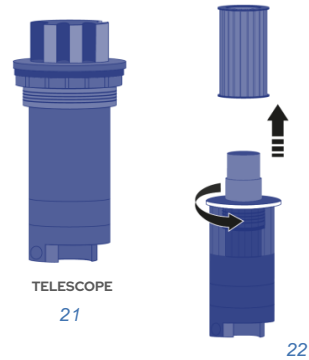

! ATTENTION

Remember to follow all the steps and to close the valve to avoid damaging the hot tub and prevent any accidents.

6.6. Spotlight maintenance

The only spotlight maintenance that may be required is the replacement of the lamp. Follow the steps below to replace the lamp. It is not necessary to drain the water from the hot tub:

1. Remove the wooden panel on the side where the hot tub's spotlight is installed, using a screwdriver if necessary.
2. To replace the lamp, turn the bulb socket anticlockwise and remove the lamp and replace it.
3. After replacing the faulty lamp with a new one, return the bulb socket to its housing and reinstall the hot tub's wooden side panel.

If you are unsure or have questions about the above process, contact your dealer or authorised technical service.

IMPORTANT – RISK OF ELECTRIC SHOCK

- Make sure that no power is being supplied to the hot tub.
- The new lamp must have the same characteristics as the one supplied with the hot tub.
- Never install a lamp without a front lens.
- Make sure that it is properly sealed. Check the condition of the gasket and replace it.

7. ERROR CODES

Type	Description	Cause	Solution
Er	Temperatures unsuitable for use have been reached	Temperature >45°C or <5 °C	Restore the temperature to the correct range (45>x>5°C)
FLO	The filtration pump is activated but the probe is not detecting water	No water flow	Restart the controller.
LL	The minimum level sensor is not detecting the amount of water required to activate the pumps	L1 has not detected water for more than 3 consecutive seconds	Return the water to the minimum level
HI	The water temperature is above 42°C	Water temperature >42°C	Water temperature ≤40°C
AL1	After filling for 60 minutes (with the hot tub initially empty), the minimum level sensor (L1) is not detecting water	After 60 minutes L1=0	Restart the controller
AL2	After 60 minutes L1 has detected water but L2 has not detected water	After 60 minutes L1=1 and L2=0	Restart the controller
AL1	After draining for 60 minutes, L1 is not detecting water	After 60 minutes L1=0	Restart the controller
Adr	After draining for 60 minutes, L1 is still detecting water	After 60 minutes L1=1	Restart the controller

8. TROUBLESHOOTING

Problem	Cause	Solution
Nothing turns on	RCD in OFF position	Turn RCD ON
FILTRATION		
Low water flow rate during filtration	Dirty or clogged filter	Wash the filter
Filtration pump not starting	Broken filtration pump	Check the pump / Replace brushes
	Contactor damaged or has faulty connection	Installer: Check connection cables. Replace contactor
	The control panel's cable is disconnected from the board	Connect the cable to the board
	Lack of power	Check the pump's connection to the electrical panel
WATER MASSAGE		
Massage pump not starting	The digital control panel's cable is disconnected from the board	Connect the cable to the board
	Lack of power	Check the pump's connection to the electrical panel
	Damaged pump	Check the pump / Replace brushes
	Contactor damaged or has faulty connection	Installer: Check connection cables. Replace contactor
HEAT EXCHANGER		
Thermostat not setting temperature correctly	Poorly placed temperature probe	Place the probe in its housing
	Faulty temperature probe	Replace the probe
	Faulty temperature control	Replace the control
Water not heating up	Poorly wired / faulty resistor	Check resistor wiring / Replace resistor
	Poorly wired / faulty flow switch	Check flow switch wiring / Replace flow switch

9. RECYCLING AND THE ENVIRONMENT

Your hot tub contains electrical and/or electronic equipment and, as such, at the end of its service life it should be treated accordingly as special waste.

Contact your local authorities to find out the procedure for collecting and treating waste from electrical and electronic equipment.

