

SPAVIDA

**Badewanne mit
Hydromassage**
Montageanleitung
Service-Karte

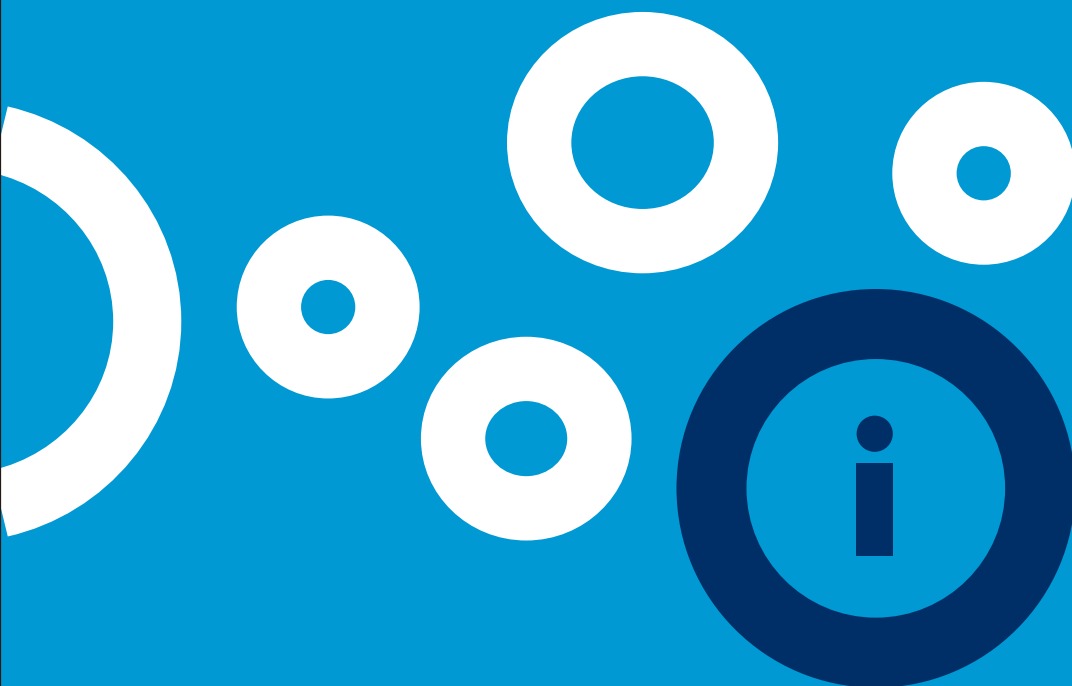

Wichtige Informationen:

Ordernummer: _____
Seriennummer: _____

SPAVIDA

WICHTIGE SICHERHEITSANWEISUNGEN ZUR VERWENDUNG BITTE LESEN UND FÜR DIE ZUKUNFT AUFBEWAHREN!

1. Das Anschließen der Badewanne mit Hydromassage an die elektrische Anlage darf nur von entsprechend qualifiziertem Elektriker ausgeführt werden.
2. Die Badewanne mit Hydromassage darf nur an eine Versorgungsanlage angeschlossen werden, die den Parametern entspricht, die auf dem Typenschild angezeigt wurden, eine ordnungsgemäß funktionierende Erdung ist obligatorisch.
3. Während der Installation überprüfen Sie die Erdung der Metallkonstruktion der Badewanne. Auf der Metallkonstruktion der Badewanne gibt es eine Equipotentialverbindung, an die der lokale Ausgleichsanschluss mit anderen Metallelementen zu verbinden ist, nach den in einem solchen Fall geltenden, örtlichen Gesetzen des Bestimmungslandes.
4. Installation der Versorgung muss mit einem Fehlerstromschutzschalter von einem Ausschaltstrom von maximal 30 mA ausgerüstet werden. Überprüfen Sie regelmäßig die Funktion des Fehlerstromschutzschalters. Darüber hinaus sollte die elektrische Anlage mit einem Schalter mit Kontaktlücken auf allen Polen ausgestattet sein, die eine volle Abschaltung unter Überspannungskategorie III ermöglichen, in Übereinstimmung mit den Anforderungen dieser Installation.
5. Spannungsführende Teile (mit Ausnahme der Elemente, die mit niedriger, sicherer Spannung von 24 V versorgt werden) müssen vor Eingriff geschützt werden (Die Badewanne sollte mit entsprechender Verkleidung versehen werden).
6. Das Gerät kann von Kindern von mindestens 8 Jahren und von Personen mit eingeschränkten körperlichen und geistigen Fähigkeiten wie auch von Menschen mit mangelnder Erfahrung benutzt werden, wenn eine Aufsicht gewährleistet wird oder wenn diese Personen über die sichere Verwendung der Geräte auf solche Art und Weise geschult worden sind, dass sie die damit verbundenen Risiken verstehen. Kinder sollten nicht mit dem Gerät spielen.
7. Kinder sollten die Reinigung und Wartung der Badewanne ohne Aufsicht nicht durchführen.
8. Im Falle von Schäden an der Stromleitung, um die Gefahr zu vermeiden, den Austausch der Stromleitung kann nur eine Fachwerkstatt oder eine entsprechend qualifizierte Person durchführen. Der Installateur hat die Pflicht, die minimale Länge des Stromkabels und Ausgleichskabels so festzustellen, damit diese nicht beschädigt werden, falls die Badewanne aus der Verkleidung herauszunehmen ist (z. B. im Notfall).
9. Führen Sie keine Wartungsarbeiten während des Betriebs des Gerätes.
10. Im Falle einer Verkleidung der Badewanne mit Fliesen muss dieser Vorgang so durchgeführt werden, dass die Wanne herausgenommen werden kann, um die Reparatur ohne Beschädigung der Badewanne und Fliesen durchzuführen. Bei dem Einbau sollten die Abmessungen der Wanne, die jeweils eine Messung vor dem Einbau erfordern, berücksichtigt werden.

Die Nichteinhaltung dieser grundlegenden Sicherheitsregeln führt zum Verlust der Reklamationsrechte. Der Hersteller haftet nicht für Schäden an Personen und Sachen, die durch unsachgemäße Installation oder Nutzung verursacht wurden.

Whirlpool C667S USER MANUAL 180x120x68cm

Wasservolumen Minimum: 260 Liter

Wasservolumen Maximum: 350 Liter

Gewicht: ca. 120 kg

Montage und Bedienungsanweisung Instructions
for installation & operation



Index

■ HINWEISE ZUM AUFBAU	5
■ BEDIENUNGSANLEITUNG	6
■ INSTANDHALTUNG	7
■ SICHERHEITSHINWEISE	7
■ GEBRAUCHSANWEISUNGEN DES BEDIENUNGSFELDS	8



■ Notice	14
■ Water and Power sketch Map	15
■ Installation sketch	16
■ Instructions for use the bathtub	17
■ Trouble analysis and obviation	19
■ Maintenance	20
■ Instructions for use the control panel	22
■ System install sketch	23
■ Operation instructions	25

HINWEISE ZUM AUFBAU

Vor der Installation

- Sorgen Sie für ausreichend Platz am Aufstellort der Badewanne.
- Stellen Sie sicher, dass der Stromanschluss wassergeschützt und isoliert ist.
- Vermeiden Sie die Benutzung scharfkantiger Werkzeuge und Gegenstände in der Badewanne.

Installation

- Legen Sie die Anschlüsse für Wasser (½ Zoll), Strom und Abfluss (1 ½ Zoll) gemäß der Skizzen (siehe unten).

- Wenn Sie sichergestellt haben, dass die Zuleitungen und Anschlüsse korrekt verlegt sind, können

Sie die Badewanne anschließen und mit den Wasser- sowie Stromanschlüssen verbinden.

o Abfluss: Verbinden Sie den Abflussschlauch unter der Badewanne mit dem dafür vorgesehenen Loch im Wannenboden und dichten Sie ihn dort ab.

o Wasseranschluss: Verbinden Sie die Warm- und Kaltwasserleitungen mit den jeweiligen Anschlüssen.

o Stromanschluss: Stellen Sie sicher, dass der Anschluss wasserdicht und der FI-Schalter mit der Elektrobox verbunden ist. Schließen Sie dann den Stromstecker an den Stromanschluss an.

- Richten Sie die Badewanne mithilfe der schraubbaren Füße waagrecht aus.

- Prüfen Sie erneut, ob alle Anschlüsse und Zuleitungen korrekt verlegt, angeschlossen und ggf. wasserdicht sind.

- Lassen Sie nun Wasser in die Badewanne, um die Funktionen zu überprüfen.

BEDIENUNGSANLEITUNG

Wasserdüsenmassage

Schalten Sie die Wasserdüsenmassage über das Computerpanel ein und aus. Mithilfe des Drehknopfes ("knob") können Sie die Luftbeimischung steuern.

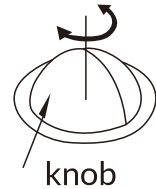

Große Wasserdüse einstellen

An den großen Wasserdüsen ("adjustable nozzle") können Sie eine beliebige Richtung des ausströmenden Wassers vorgeben und die Intensität steuern.



Wasserablauf

Drehen Sie den Wasserablaufknopf ("knob 2") im Uhrzeigersinn für – nicht weiter als ca. 45 Grad – um das Abflussventil anzuheben, damit das Wasser aus der Badewanne ablaufen kann. Drehen Sie entgegen dem Uhrzeigersinn um das Ventil wieder zu schließen und den Wasserablauf zu stoppen.

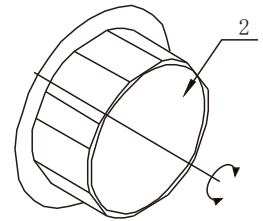

Reinigung des Ablaufventils

Sollte das Abflussventil nach mehrmaliger Benutzung der Badewanne verstopft sein, können Sie das Ventil entnehmen und reinigen. Heben Sie dazu die Abdeckung an und waschen Sie sie aus.

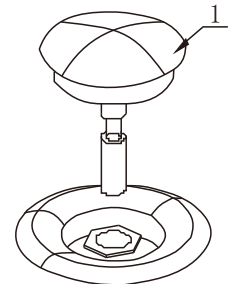

INSTANDHALTUNG

- Benutzen Sie ein weiches, trockenes Tuch um die Badewanne zu reinigen.
- Kleinere Flecken können mit einem weichen, feuchten Tuch oder Schwamm und Badreiniger entfernt werden. Bitte benutzen Sie keine Nylonprodukte, um Abnutzungserscheinungen in der Badewanne zu vermeiden.
- Sollte die Abdichtung abgenutzt sein, erneuern Sie diese bitte.
- Reinigen Sie das Wasserkreislaufsystem alle zwei Wochen. Lassen Sie dazu die Badewanne mit Wasser volllaufen und schalten Sie sie ein.
- Wenn Sie die Badewanne für längere Zeit nicht genutzt haben, lassen Sie zuerst sauberes Wasser für ca. 3 bis 5 Minuten einlaufen und anschließend wieder ablaufen.
- Schalten Sie das Gerät zuerst aus bevor Sie das Wasser ablaufen lassen um Wasserrückstau in den Leitungen zu vermeiden.

SICHERHEITSHINWEISE

- Die elektrische Installation darf nur durch einen Fachmann durchgeführt werden.
- Verwenden Sie ausschließlich sicheres und wassergeschütztes Equipment.
- Lassen Sie zuerst kaltes Wasser in die Badewanne, danach warmes Wasser. Wenn der Wasserstand die Luftmassagedüsen überstiegen hat, können Sie Luftdüsen einschalten.
- Sorgen Sie für eine gleichmäßige Stromspannung, andernfalls kann die Badewanne nicht benutzt werden.
- Schalten Sie das Gerät nach der Benutzung aus.
- Lassen Sie die Luftdüsenmassage aus Sicherheitsgründen nicht länger als eine Stunde laufen.

* Design- und Größenänderungen vorbehalten.

* Das gelieferte Produkt kann von den Produktabbildungen abweichen.

* Wir behalten uns das Recht auf Änderungen vor.

Das Produkt fällt unter Sondermüll und darf nicht im Haushaltsmüll entsorgt werden.

COMPUTERPANEL Gd7001 ANSCHLUSSSKIZZEN

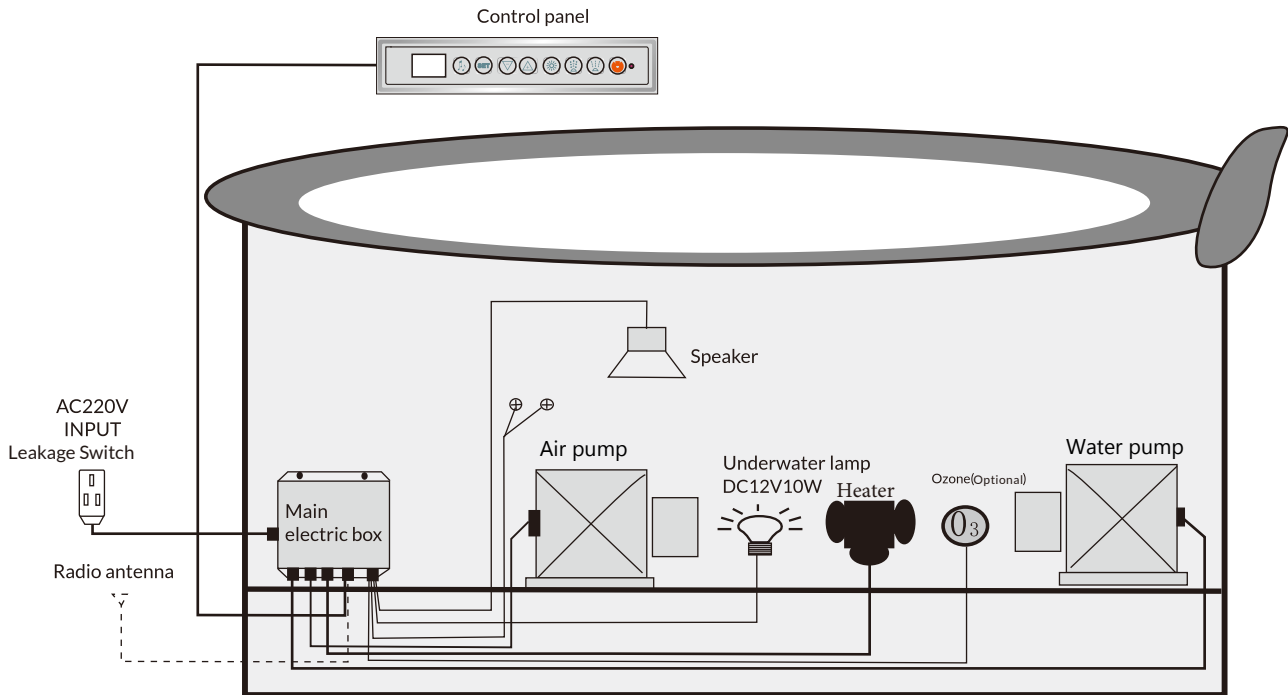

LEGENDE

Control Panel	=	Computerpanel
Input	=	Stromanschluss
ANT	=	Antenne
Main box	=	Elektronikbox
Water Sensor	=	Wasserstandserkennung
Bubble Bath Pump	=	Luftpumpe
Speaker	=	Lautsprecher
Lamp	=	Beleuchtung
Heater	=	Heizung
Ozone	=	Ozonreinigung
Pump	=	Wasserpumpe

COMPUTERPANEL

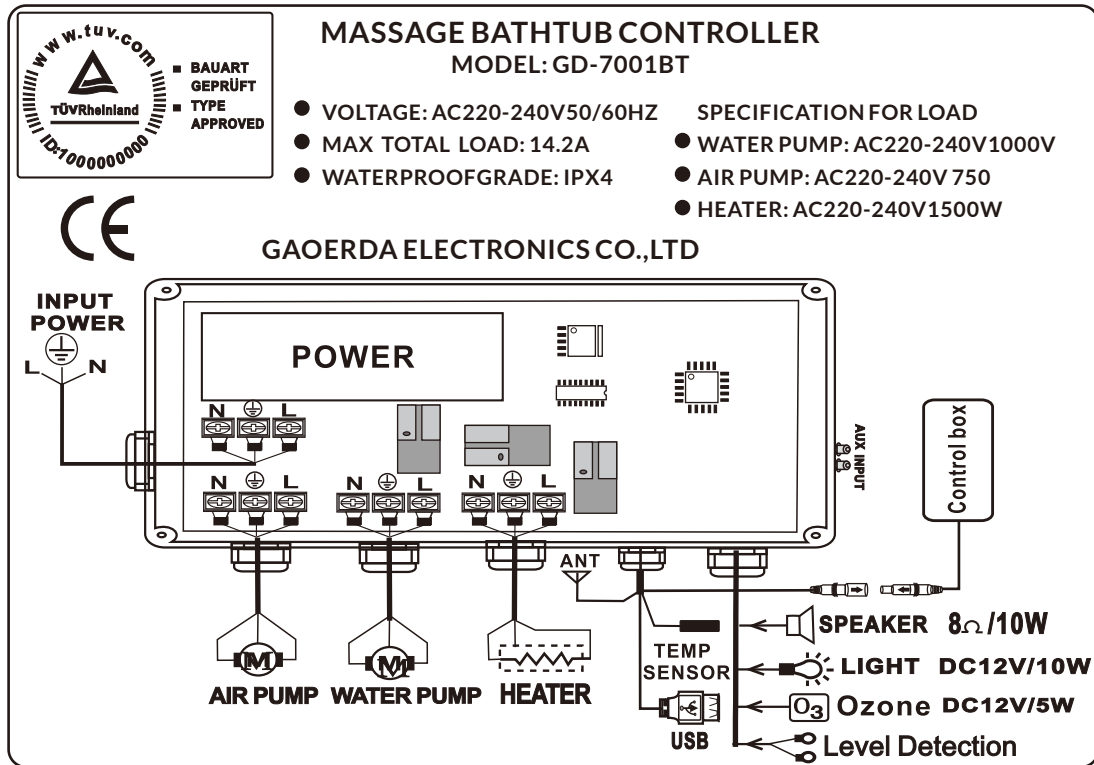

LEGENDE

Input	=	Stromanschluss
Water pump	=	Wasserpumpe
Air pump	=	Luftpumpe
Heater	=	Heizung
Speaker	=	Lautsprecher
Light	=	Beleuchtung
OzoneLevel	=	Ozonreinigung
Detection	=	Wasserstandserkennung
ANT	=	Antenne

COMPUTERPANEL

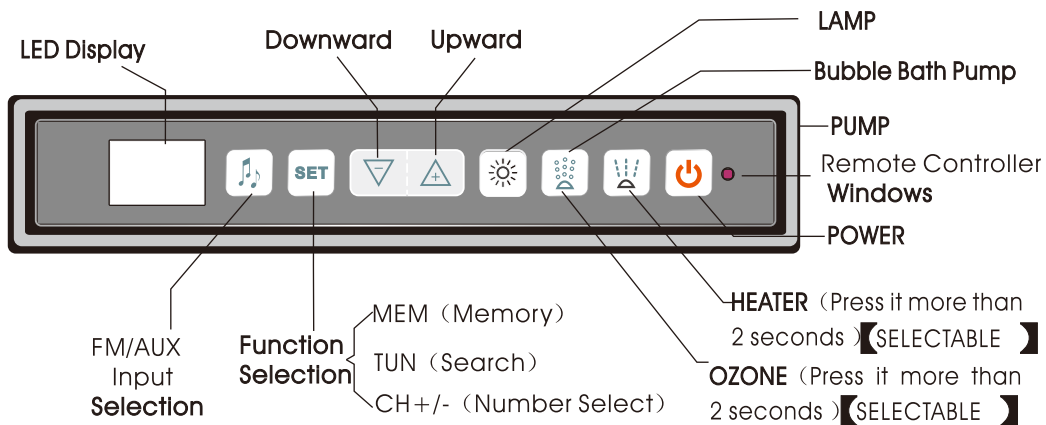



LEGENDE

LCD Display	=	LCD-Anzeige
Downward	=	Abwärts
Upward	=	Aufwärts
Lamp	=	Beleuchtung
Bubble Bath Pump	=	Luftpumpe
Pump	=	Wasserpumpe
Power	=	Ein- / Ausschalten
Heater	=	Heizung (zur Aktivierung 2 Sekunden gedrückt halten)
Ozone	=	Ozonreinigung (zur Aktivierung 2 Sekunden gedrückt halten)
Set	=	Funktionsauswahl (Frequenzspeicher, Radiotuner, Kanal wechseln)
FM / AUX	=	Radio- / CD-Funktion



BEDIENUNGSANLEITUNG

1. Ein- / Ausschalten

Drücken Sie die () Taste, um das Gerät einzuschalten. Auf der LCD-Anzeige erscheint "SPA". Danach können Sie die gewünschten Einstellungen vornehmen. Drücken Sie die () Taste erneut, um das Gerät auszuschalten.



2. Wasserdüsenmassage

Lassen Sie bitte zuerst ausreichend Wasser in die Badewanne ein. Wenn das () Zeichen ausgeht, ist der empfohlene Wasserstand erreicht.



Drücken Sie die () Taste, um die Wasserpumpe zu starten. Auf der LCD-Anzeige wird dieses Symbol ebenfalls angezeigt. Drücken Sie die () Taste erneut, um die Wasserpumpe zu stoppen.

Bitte beachten Sie: Wenn der erforderliche Wasserstand nicht erreicht ist, wird die Pumpe nicht gestartet. Lassen Sie dann bitte ausreichend Wasser ein. Außerdem schaltet sich die Pumpe automatisch nach 60 Minuten ab.



3. Heizung

Die Heizung kann nur eingeschaltet werden, wenn die Wasserpumpe aktiviert ist. Halten Sie zum Start der Heizung die () Taste für 2 Sekunden gedrückt. Auf der LCD-Anzeige wird das () Symbol angezeigt. Blinkt dieses Symbol auf, so können Sie die Heizung ordnungsgemäß nutzen. Sollte das Symbol dauerhaft leuchten, schaltet sich die Heizung ab, weil die erforderlichen Voraussetzungen nicht erfüllt sind.

4. Luftdüsenmassage

Drücken Sie die () Taste, um die Luftpumpe einzuschalten. Auf der LCD-Anzeige wird das () Symbol angezeigt. Drücken Sie die Taste erneut, um die Luftpumpe auszuschalten.

5. Beleuchtung

Drücken Sie die () Taste, um die Beleuchtung ein- bzw. auszuschalten. Auf der LCD-Anzeige wird das () Symbol angezeigt.

6. Ozonreinigung

Halten Sie die () Taste für 2 Sekunden gedrückt, um die Ozonreinigung zu starten. Auf der LCD-Anzeige wird das O_3 Symbol angezeigt.

Nach 15 Minuten schalten sich die Ozonreinigung selbstständig aus. Sie können die Reinigung vorher beenden, indem Sie die Taste für 2 Sekunden gedrückt halten.

7. Radio

Drücken Sie die () Taste, um die Radiofunktion zu aktivieren. Auf der Anzeige werden die Frequenz und die Lautstärke angezeigt.

Frequenzsuche: Halten Sie die () Taste für 2 Sekunden gedrückt. Auf der Anzeige erscheint "TUN". Mit den Aufwärts- und Abwärts- Tasten können Sie die Frequenz ändern.

Frequenz speichern: Drücken Sie die () Taste, um die ausgewählte Frequenz zu speichern. Es stehen die Kanäle M-01 bis M-10 zur Verfügung.

Gespeicherte Frequenz aufrufen: Drücken Sie die () Taste, um den entsprechenden Speicherplatz aufzurufen. Auf der Anzeige erscheint CH01 bis CH10. Wählen Sie aus den angezeigten Kanälen die gewünschte Station.

8. Lautstärke

Drücken Sie die Tasten zur Lautstärkeveränderung, um die Lautstärke zu verringern (▽) oder zu erhöhen (▲) .

9. CD-Wiedergabe

Drücken Sie die () Taste, bis "AUX" aktiv ist. Stellen Sie die gewünschte Lautstärke mittels Lautstärketasten ein. Bitte beachten Sie: Zur Wiedergabe von CDs ist ein externer CD-Spieler notwendig.

BENUTZUNGSHINWEISE

1. Bitte lesen Sie die Anleitung sorgfältig und halten Sie sich an die Angaben.
2. Bitte berühren Sie keine Oberflächen oder Teile, die mit einem Hochspannungsaufkleber versehen sind.
3. Bitte schützen Sie das Computerpanel vor starker Hitze und Feuchtigkeit.
4. Bitte achten Sie darauf, dass Sie nur sauberes Badewasser benutzen. Andernfalls können die Leitungen beschädigt und verstopft werden.

PROBLEMBEHEBUNG

1. Warum funktionieren Wasserpumpe, Luftpumpe oder Heizung nicht?
 - Bitte stellen Sie sicher, dass der erforderliche Wasserstand erreicht ist.
 2. Funktionen wie Beleuchtung, Lautsprecher und ähnliche sind nicht intakt.
 - Bitte stellen Sie sicher, dass die entsprechenden Kabel richtig angeschlossen sind. Sollten Ozonreinigung und Beleuchtung nicht funktionieren, überprüfen Sie bitte die Sicherung.
 3. Die Lautsprecher geben keinen Ton wieder.
 - Bitte stellen Sie sicher, dass das Radio eingeschaltet ist. Überprüfen Sie, ob durch Erhöhen der Lautstärke nun Ton wiedergegeben wird. Sollte dies nicht der Fall sein, stellen Sie bitte sicher, dass die Lautsprecher richtig angeschlossen sind.
 4. Es werden nur wenige Radiofrequenz oder Radiostationen mit schlechtem Signal empfangen.
 - Bitte überprüfen Sie die Positionierung der Radioantenne und richten Sie sie ggf. neu aus.
-

Notice

1.This product needs to be installed and debugged by a qualified electrician.

2.The power supply of this product should has special circuits, there must be good grounding line of protection, the cable should be fixed for ever, the sectional area of the power supply cable should be thicker than $\geq 4\text{mm}^2$, users must install electric leakage switches in the supply line that the movement electric current is 30mA and the specified electric current is 16A.

3.The power as AC 220V $\pm 10\%$, 50HZ. (Products for export is customized as required). AC110/60Hz also available.

4.The water pressure as 0.2~0.6Mpa.

5.The temperature of hot water supplied to the bathtub Should be cooler than 70°C.

6. Maintaining must go on under the disconnection power.

7. A child, old man without self-care ability mustn't use alone.

8. Strictly prohibit to start the water pump while no water, so as not to damage the seal gasket of the water pump.

9.This equipment not supply to the people who with low corporeity, slow reaction or mental impediend, and including children, if this or such people need to use this equipment that a security responsibility for the guidance or assistance of safe is require. Children must be under the protection of an adult to use this equipment, so as to ensure its process is not in the shower caused play equipment unknown danger.

10.The grounding quipment should always be connected to the fixed cabling. And It should be install a whole extreme switch on the location of over 3mm of the connection point in the fixed cabling.

Note:

1. The content in this manual, is the total introduction for the function of all types and configuration, it is not all models that have these functions and configuration.

2. The products of our company are altered the old and bringing forth the new constantly, if has content difference with the original manual, will not issue a separate notice, please forgive.

Water and Power Sketch Map

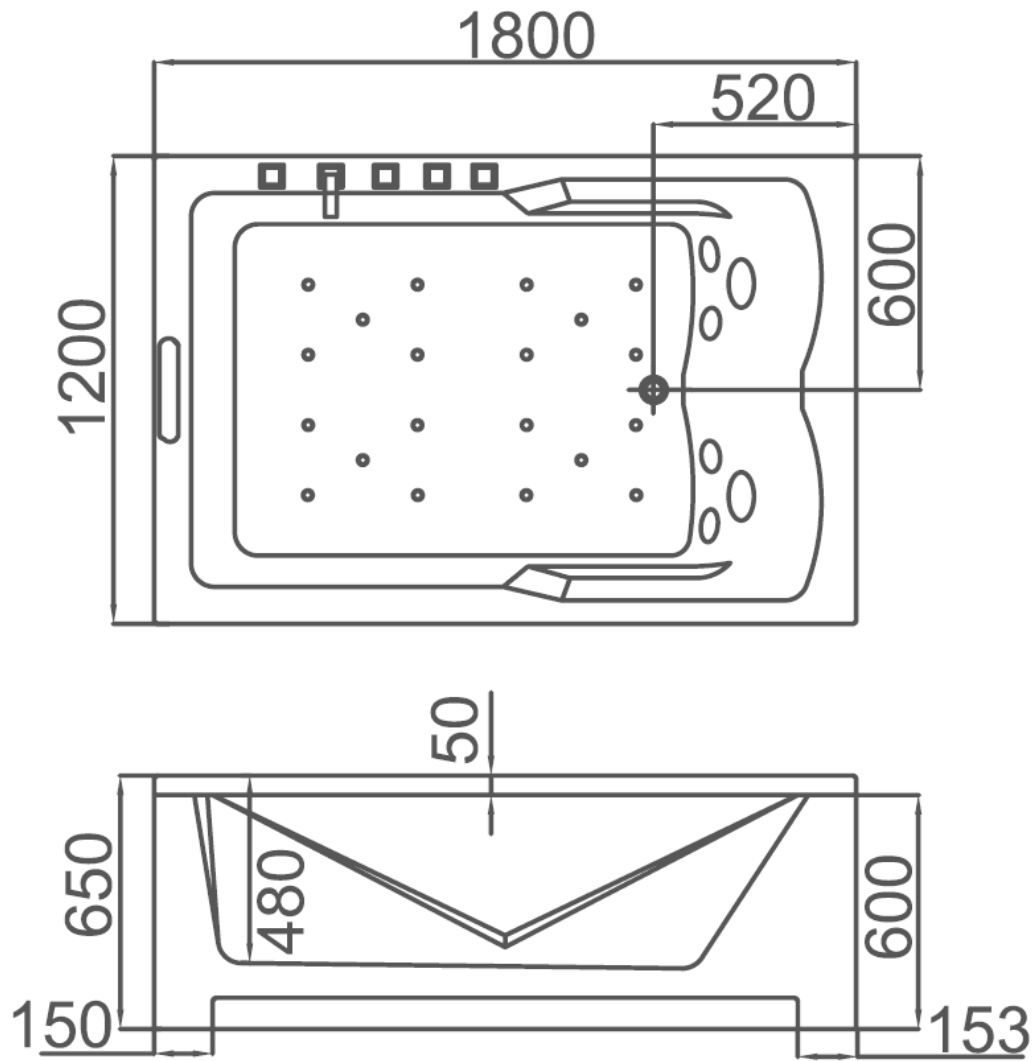

Installatlon Sketch

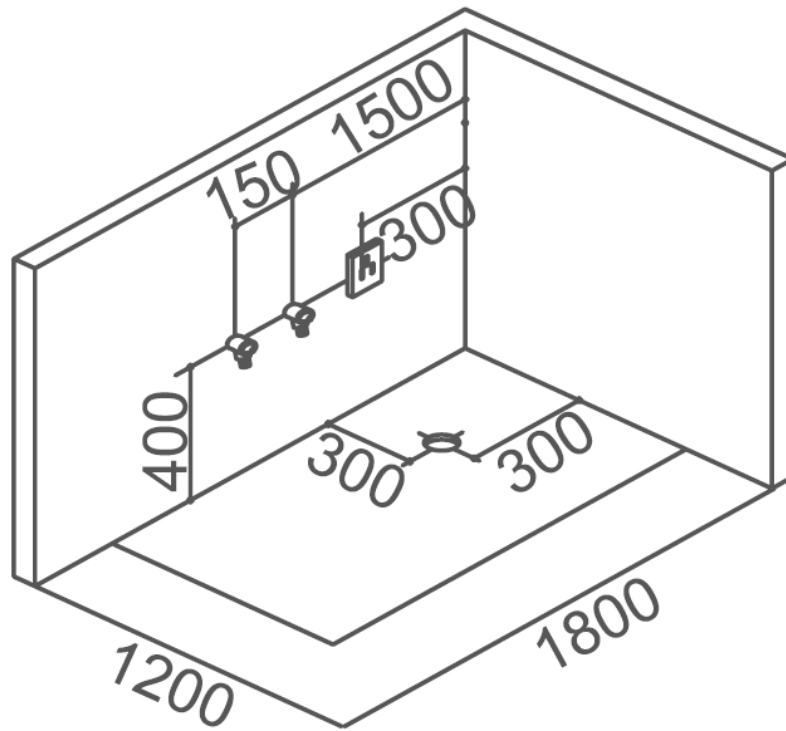

Technical parameter

Model	Specified Voltage/V	Frequency /Hz	Water pump/w	Blower /w	The maximum size /mm
Whirlpool C667S	220/110	50/60	1.2HP	700	1800x1200x680

Instructions for use the bathtub

1.Operation method for water power massage Press it for the first time to open the circulating water function, press it once again to close. With the help of the "knob" you can control the air admixture.

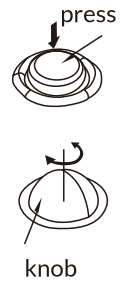

3.Operation method for the cool hot water switch.

Lift the hand of the handle of cool hot water switch outwards, turn left can flow hot water and contrariwise the cold water. Control the left and the right angle properly, let the cold and hot water mixed to reach the temperature that the you needs.

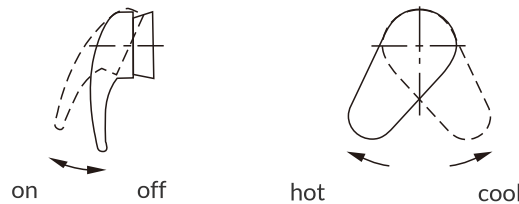

4.The below ketch shows the distribute water switch, turn the distribute water switch, make the red point aim at the marks, and the corresponding one can flow water.

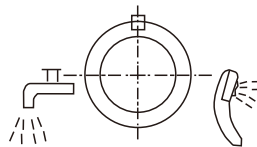

5. Usage of the adjustable spray nozzle of waterpower massage of the bathtub.



The adjustable spray nozzle can be deflexion random. namely adjust the direction of spray water.Can adjust the strength of the waterpower massage by turning the strength switch of the bathtub.

SPAVIDA

6. Usage of the draining off water device: (with bathtub)

A) Drain off water.

Rotate the knob 2 on bathtub clockwise (about 30° - 45°)(Fig. as below), can turn on the valve 1 upwards, so the water in the bathtub can be drained completely. Rotate the knob 2 contrariwise (about 30° - 45°) can close the valve 1.

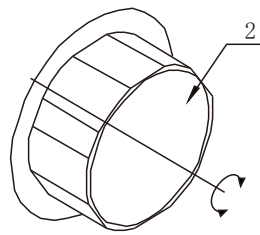

B) Cleanness of the valve that drain off water:

If the drainage was jammed after the steam room has already been used for some time, should clean out the deodorizing drainage. (the following sketch)

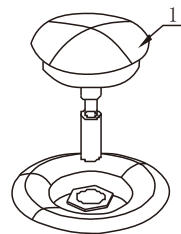

(with the bathtub)

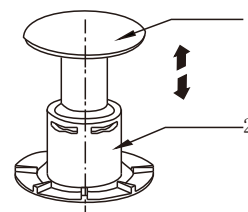

(no bathtub)

7. Usage of the hand shower:

There are six kinds of marks on the hand shower (such as the right sketch),if user swivel the orientation ornament ring on the shower (such as the left sketch), can experience different water spray fashion

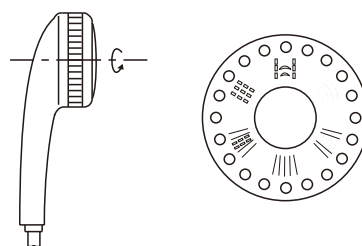

Trouble analysis and obviation

Phenomenon	Reason	Solution
The water pump does not operate	<ol style="list-style-type: none"> 1. The air switch is not tight, and leak pressure. 2. Air switch are ineffective. 3. The plug not be inserted or power supply abnormally. 4. There are sundries that blocks the water pump impeller. 5. The water level not reached the height stipulated. 	<ol style="list-style-type: none"> 1. Insert the air pipe closely. 2. Adjust the air switch. 3. Insert the plug closely. 4. Remove sundries. 5. Add water to the suitable height.
Can't adjust the massage strength	<ol style="list-style-type: none"> 1. Power supply is abnormal. 2. The strength adjusting does not act. 3. The large air pipe not been inserted closely. 	<ol style="list-style-type: none"> 1. Insert the plug closely. 2. Adjust the strength adjusting. 3. Insert the air pipe closely.
The water pipe leaks	<ol style="list-style-type: none"> 1. Seal gasket is not good. 2. The nut not been locked tightly, interface place sticking is bad. 3. The inner layer in the water pipe breaks. 	<ol style="list-style-type: none"> 1. Change the seal ring. 2. Screw down the nut, and seal the interface. 3. change the water tube.
The submarine light is not bright	<ol style="list-style-type: none"> 1. The fuse of the light is melted. 2. No water in the bathtub or the water not high enough. 3. The light bulb has been out of order. 	<ol style="list-style-type: none"> 1. Change the fuse with specification. 2. Add water to be higher than the nozzle. 3. Change the light bulb.

SPAVIDA

Can't control	The control line not be connected well.	1. Reconnect the control line.
Whistling in a talking	The volume key of the keyboard is turned too high.	1. Turn volume down properly.
The radio reception is bad	1. The Model Y aerial not been drawn well. 2. The frequency of radio station not been set well.. 3. Users are in the weak signal area.	1. Draw back the "Y" antenna, and make it to the best direction 2. set the frequency of radio station again. If it is not good to set automatically, can adjust it manually.
The total plug trips	1. There is leakage of electricity in water pump or in other load. 2. The total outlet itself has already been damaged.	1. Check and change the leak electricity load. 2. Change with the same sharp plug.

Maintenance

1. Can clean with liquid detergent and soft cloth, Pay attention to not to use the acetone, alcohol, ammonia and materials containing organic solvent to wash. If want to pasteurize, don't use the formic acid and formaldehyde products, Otherwise will damage the bathtub surface.

2. Use the polishing compound to polish and make the surface keep bright.

3. Can wash up surface scale with soft cloth soaked with citric acid, had better soft cloth soaked with hot citric acid, some dirties cant be wiped out by soft cloth pained with toothpaste.

4. If the room body surface has slight scotch or cigarette burn, can use toothpaste and soft cloth to polish.

5. Maintenance of chromium-plating parts: Wipe the chromium-plating parts lightly with the cotton f lannel; make sure not to polish with the coarse cloth.

SPAVIDA

6.Maintenance of the bathtub: As the bathtub has the scale or slight scotch, can polish it with toothpaste and soft cloth.

7.Washing the water power massage device: Add hot water of 40°C to the bathtub to full,Put into sanitizer 2 gram per liter water,Start the water power massage system about 5 minutes,Stop the pump and drain off water, then add the cold water fully,restart about 3 minutes of water power massage,clean bathtub after stopping the pump and draining off water.

8.As using water power massage, don't use the excessive plant cosmetics, in case that the screen panel of return water be jammed.

9.Should clear up the return water screen panel of the water pump for using every 30hours, so as not to be jammed.

10.If not use for a long time, should close the master power, for fear that the machine be in the state of waiting for a long time.

11.As water in the bathtub is higher than the spray nozzle, can you turn on the water pump, and the operation of the electrical engine of the water pump has stopped, can you drain off water. For fear that damage the water pump as it runs in idleness at the state of no water.

12. After the bathtub been installed, seal up all connection slot between the bathtub and the wall body with the white neutral glass cement and can use it formally 24 hours later

13.Before and after the use of this equipment it should be notice to the cleanness sanitation; In order to aviod any damage to the equipment it's not allow too rude to use this equipment. Do not touch with such as ink or feculency to the crust of the equipment; after each use, it's request to clean with soft cotton towels lightly and let it dried naturally; In order to avoid circuit fault, the circuit can not contact with the water during cleaning.

14.The grounding quipment should always be connected to the f ixed cabling.

15.It should be install a whole extreme switch on the location of over 3mm of the connection point in the f ixed cabling.

16.In the cold winter ,the temperature should not be set too high when you use it first , set the steam temperatures slightly higher than the room temperature, then you should raise the temperature twice till you need.

17.The old hose do not allow repetition use, it should be use the new hose which was accompanying with this equipment.

18.If the electrical line damage, it should be call for a professional electrician to check so that can aviod the danger.

Instructions for use the control panel

1. PRODUCTS FUNCTION:

Thanks for your choosing and buying the Products. Before you are going to use it, please read this user manual carefully. It can tell you how to use and it. Then you can use all functions. It has many functions.

1. Highly sensitive water level sensor
2. Bubble bath massage function
3. Surfing function
4. FM Digital Turing Radio and Double Power Amplifier
5. Ozone sterilization function (SELECTABLE)
6. Expand audio input function
7. Underwater lamp function
8. Almighty remote controller
9. Touch Technology function
10. Exterior heating apparatus function (SELECTABLE)

2. SPECIFICATIONS

1. Power Supply: AC220V 50-60HZ
2. PUMP Load: $\leq 1000\text{w}$ AC220V
3. Bubble bath pump Load: $< 750\text{W}$ AC220V
4. S/N ratio: $> 45\text{dB}$
5. Leak current: $< 0.25\text{MA}$
6. Ozone Load: $\leq 10\text{W}$ AC12V (SELECTABLE)
7. HEATER Power: $\leq 1500\text{W}$ AC220V (SELECTABLE)
8. Dielectric strength: 1500v, 1min
9. Lighting load: $\leq 20\text{W}$ AC12V
10. Music power: $< 10\text{W}$ 80
11. Frequency range: FM88-108MHZ
12. Waterproof grade: IPX4

SPAVIDA

3.SYSTEM INSTALL SKETCH

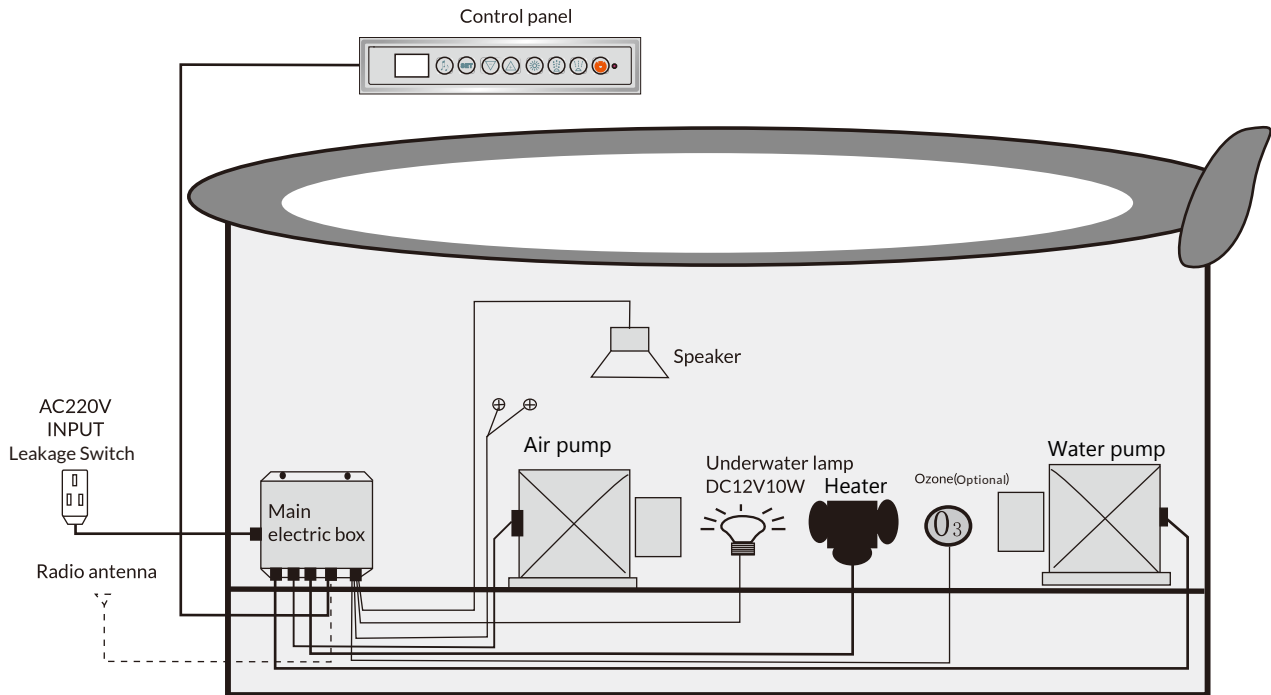

SPAVIDA

4. THE ASSAGE BATHTUB CONTROL CONNECT SCHE AT CS

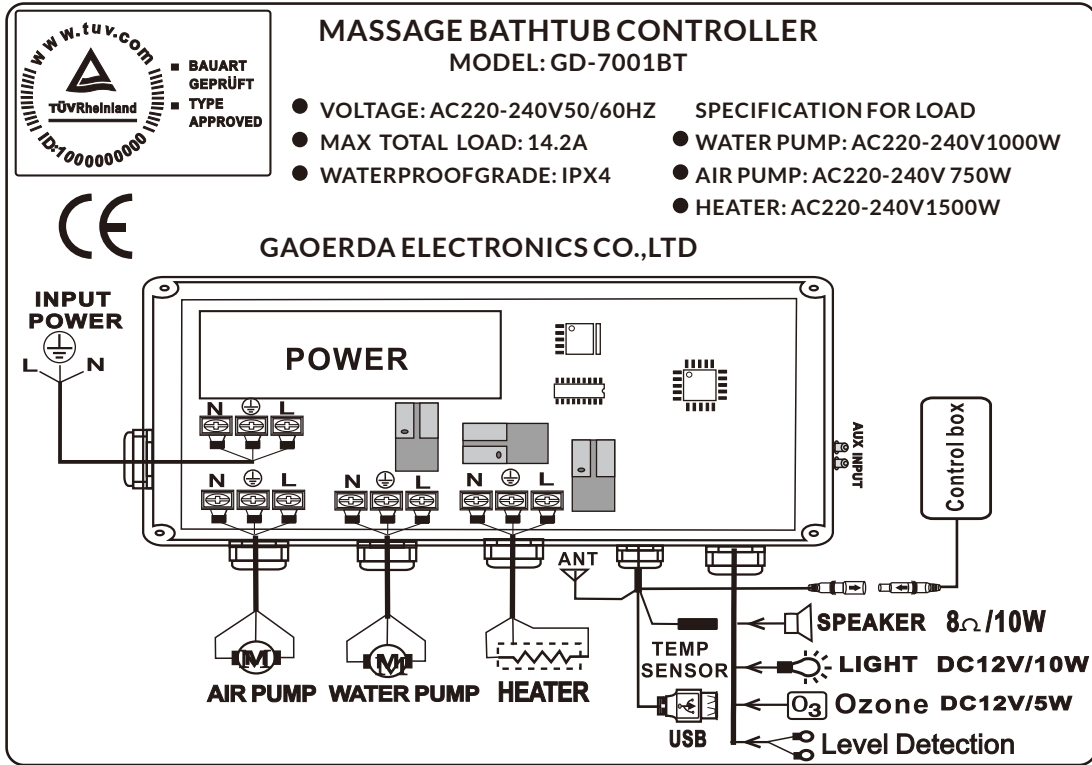

5. PANEL FUNCTION DESCRIPTION

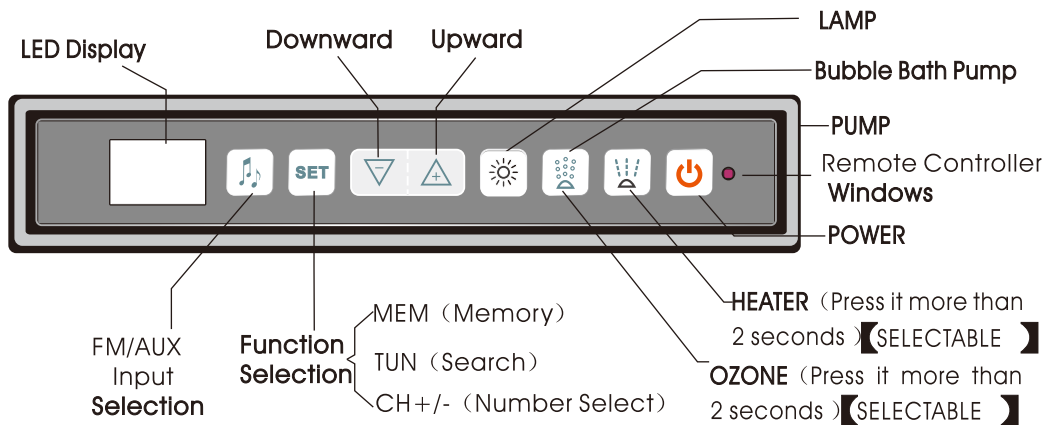

7. OPERATION INSTRUCTION:

1. Surfing section:



(1) ON-OFF operation of the system:

After turning on the creepage switch, the system will be electrified and pressing of power key() will start the system, The display screen will appear (SPA), and display the temperature. By this time you can perform setting and operation of various functions according to the requirement of users.





Switching-off: The system can be directly switched off by pressing power key()





Mode has heating function can set the Preferences temperature: must setting at music function close status.

press() or () to change the Preferences temperature, only in the status of (radio/AUX off). The Preferences temperature can be set between 30C to 45C, when the water temperature reach the Preferences temperature, the heater will come to the status of constant temperature.



2.Surfing function:



Firstly,fill water into the bathtub When the indicating sign() goes out, it has reached standard level,You can press surfing key() on the panel for starting of surfing pump while a dynamic surfing sign will also appear on the screen accordingly.You can switch off the surfing function by pressing surfing key() on the panel.Then the surfing pump will stop running and the surfing sign on the screen will disappear[**Note:A.When the water in the bathtub Does not reach standard level,the surfing pump will not start;only static sign()and flashing water shortage sign()appear on the screen .Then you need to fill water into the bathtub.B.When the surfing pump is activated for 60 minutes,it will switch off the function automatically.]**

3.Function of heater(SELECTABLE):

Only after starting the surfing pump can start the heating function effectively by pressing heating key() more than 2 seconds . The heating sign() will appear on the screen accordingly.If the sign is dynamic,it means that the working conditions of heater are satisfied and the system is under heating.If the sign is static,it means that the working conditions are not met and the heater will stop working.[**Note:When surfing pump is switched off,this function will also be deactivated.**]



4.Bubble bath pump Function:Press()key,the bubble bathr pump is turned on,LCD display “  ” sketch,press again() key to turn OFF.

5.Water light function:Press ()key,the water light is turned on, LCD display “  ” sketch,press again() key to turn OFF.

6.Ozone function:Press()key for over 2 seconds,the ozone is turned on,LCD display“ O3 ” sketch,press again() key for over 2 seconds to OFF.(NOTICE:The working-time of the Ozonizer is 15 minutes. So the Ozonizer auto is turned off after 15 minutes)

7. Radio section:

(1) Pull out the radio antenna and place in "Y" form. When radio () key is pressed, the screen will appear radio frequency and the volume will rise from "0" to "15" DB with slight sound for loudspeaker.

(2) SEARCH: Press the key () for more than 2 seconds, When the screen will display the "TUN" sign, Press () or () key for upward or downward frequency selection. Spot pressing is for manual selection. When the key is pressed for more than 2 seconds, the frequency will move upward or downward automatically until the broadcasting station is received. In the case of poor receiving environment or weak signal for receiving, it is recommended to select in manual selection mode.



(3) MEMORY: After selecting the broadcasting station, press () key to display "M--01" to "M--20", Then it can be stored in this Number. The total memory for station is 20. If the received broadcasting station is not ideal, please pull our antenna and adjust the direction fo antenna.

(4) Repeated hearing: Press the () key for selection of the position of desired station, the screen will display the Nunber "CH01--CH20" thus you can hear the voice.



Search and Memory procedure: Press () more than 2 secons ➔

Press () or () When displays "TUN" ➔ Press ()

Repeated hearing procedure: Press () key for what you need

(5) Volume adjustment ---The volume can be adjusted by pressing () or () key and the screen will display corresponding volume DB number.

8. Enter AUX FUNTION:

Connect the Exterior audio wire with the external Faucet of the main control box, Press () key to the position of AUX, then choose the suitable volume by pressing () or () to listen.

9. Power-off: Pressing of () key can switch off all the function while display screen set will be in standby state. In case that it is not used for long time, please pull off the master power switch.

8.Fault elimination:

Fault	Fault cause	Solution
No sound from loudspeaker	1.The volume is adjusted too low. 2.The adapter of loudspeaker has been loosened. 3.The loudspeaker is damaged.	1.Increase the volume 2.Reconnect the wire properly 3.Replace the loudspeaker
Failure of remote control	The remote control has low battery	Replace the battery
The machine cannot be activated	1.The creepage protection plug has not been electrified. 2.The control line between controller and electric box has not been connected properly.	1.Check if creepage protection plug indicating lamp has been extinguished.If the answer is yes, reconnect the power supply. 2.Reconnect the computer line properly
Underwater lamp does not light up	1.The wiring for underwater lamp is loosen; 2.The bulb is damaged.	1.Reconnect the wire properly; 2.Replace with new bulb.
Poor radio result	1.The antenna has not pulled out; 2.The radio frequency has not been adjusted properly; 3.The user is in weak signal area.	1.Pull out the antenna and place properly; 2.Readjust radio frequency properly; 3.It is influenced by geographical position.

9.ITEMS FOR ATTENTION:

1.The system must be erected by qualified technical personnel and the creepage protection switch plus shall be mounted in a place of easy control.

2.It must be connected firmly during erection.In the case of loss due to improper earthing, the manufacturer will not assume any responsibility.

3.The motor must be erected flatly and stably and the shell shall be firmly earthed.

4.The whole set is usually under standby state.If it is not used for long time,please pull off the master power switch.

5.During erection,it is required to consider load capacity of power supply circuit,otherwise it may, influence the normal working of the system or cause accident.

6.During erection,all the electric appliances and electric parts shall be provided with moisture resistant measures.

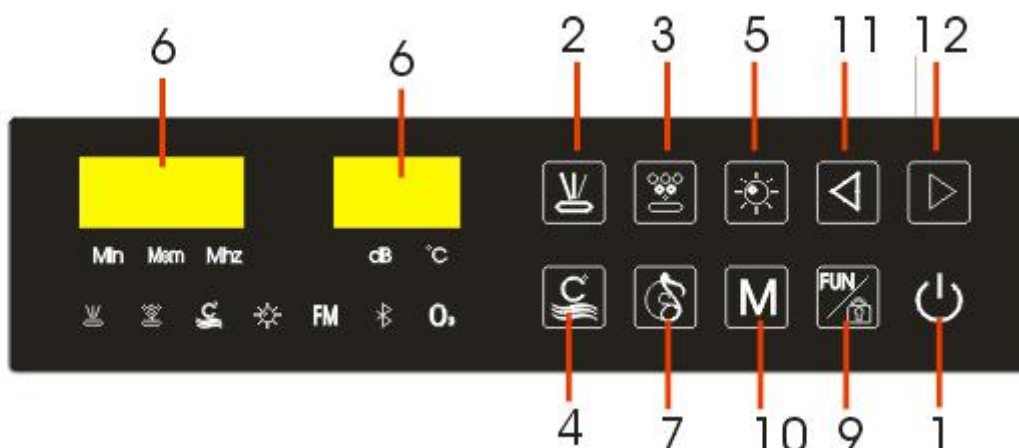

- | | |
|-----------------|---------------------|
| 1. ON/OFF key | 7. Bluetooth/FM |
| 2. Water Pump | 8. |
| 3. Air Pump | 9. SET key |
| 4. Thermostat | 10. FM Channel Save |
| 5. Lighting | 11. Minus key |
| 6. Display Area | 12. Add key |

Function

- | | |
|--------------------------|--------------|
| 1 Water Pump | 2 Air Pump |
| 3 Lighting | 4 Thermostat |
| 5 Bluetooth music player | 6 FM |
| 7 | |

Operation guide

On/Off

1. start the system

Shortly press the button  to start the system, the display area will shows the current temperature.

2. turn off

If there is no operation after the system is on, it will auto turn off in one hour.



When the system is on, shortly press the button  to turn off the system.

Water Pump

Shortly press the button to trun on or turn off the water pump function. When the water pump is on, if the bathtub is full of water, the backlight of the button  will be lit in white color and the water pump works. If the bathtub lacks of water, the water pump will stop and the backlight of the button will flashes alternately. If the bathtub is full water again, the water pump works again.



Air Pump

On/Off

When the bathtub is full of water, shortly press the button  to turn on the air pump. The backlight of the button will be lit in white color. The air pump will start with the maximum wind and will change to Level 3 in 2 seconds. Shortly press the button  again can turn off the air pump.

When the air pump is on, if the bathtub change to less of water, the air pump will be auto off.

Air pump speed adjust

When the air pump is on, shortly press the button  one time or several times until it shows and display the level of air pump shown as below: At this time press the button  or  to adjust the level of the air pump.

The range is from Level 1 to Level 5. L5 is the most strong wind. If there is no operation after settings, the system will auto get back to working mode in 3 seconds.

Thermostat



1. On/Off



The thermostat function is restricted by the water pump function. When water pump function is off, the thermostat function is invalid. When the water pump is shut off the thermostat function will be off.

When the bathtub is full of water and water pump function is on, shortly press the button  to open the thermostat function. After thermostat function is on, if the water temperature is 2 degree C lower than the setting temperature, the thermostat heater will be auto heating until the water temperature is 1 degree C higher than the setting temperature. At this time the heater will stop heating.

If the bathtub lacks of water and the thermostat function is on, the heater will stop heating. The backlight of the button  will flashes alternately in white and blue color. If the system detects full water again and water pump is on, the heater will be auto heating again.

2. Thermostat temperature adjust

When the thermostat function is on, shortly press the button  one time or several times until it shows the  icon of the thermostat temperature and display the current temperature shown as below:



At this time press the button  or  to adjust the thermostat temperature. The range is , from 25 to 42 degree C. If there is no operation after setting the temperature, the system will be back to work.

Lighting

Generally, lights starts and closes with the system. You can shortly press the button  to turn on or turn off the lights.





Radio



On/Off

When system is on, shortly press the button  to turn on the radio and the display area will show the current radio channel and frequency. If now is playing the bluetooth music, shortly press  to turn off the bluetooth music then turn on the radio. When radio is on, press  will turn off it.



Radio frequency switch

When radio is on, shortly press the setting key one time or several times until the display area shown as follows:

At this time press  or  the radio frequency will minus or add 0.1Mhz. The range is from 87.5-108Mhz. Long press  or  for 3 seconds, the system will turn up or down to search the channel. It will stop when it search the effective channel and play the it. When adjust or search the channel you need, just stop. It will back to normal work in 3 seconds.

When radio is on, press  or  can adjust the volume. The range is from Level 0 to level 15





Radio channel save and switch

When radio is on, shortly press the button  to switch to the next stored channel. Long press  for 3 seconds can save the current channel. You can save 10 channels.

Bluetooth Function



Connect and play

When system is on, use the bluetooth function on your smart device to search the bluetooth of the bathtub. For example, the name of the bathtub is BT, connect it.



If it still is in no phone or no media status, disconnect then connect again until it shows connected. Shortly press  to switch to Bluetooth Multimedia status shown as follow: If the system fails to connect to the mobile phone, the icon  in display area will be flashing and the button  on the panel will flash in white color. Please disconnect it then connect again. If connected, the display area will show the steady icon  and the button  will keep lighting

in white. At this time you can play the audio files in your smart device.

Thereafter, you can press the button  to switch different media to turn on or off the bluetooth.

When bluetooth is playing, press  or  can adjust the volume. The range is from Level 0 to 15.

Tracks Switch

When bluetooth function is on, shortly press the setting key  one time or several times until the display area shows Multimedia Settings mode shown as follow: At this time press  or  can switch the audio files as you want.

If there is a phone call when bluetooth music is playing, the music will pause. You can answer your phone. When it is end the bluetooth music will play again.

30 The bluetooth function will be off in 10 seconds after the system is off, the device will fail to connect.

Clean function

After the system is off and the bathtub is no water for 30 seconds detects water in 10 minutes). The ozone function will auto be work.

Failure Description

The LED light of the control box:

- a. LIT means the control box doesn't connect power.
- b. Always ON means the control box fails to communicate with the control panel.
- c. FLASH means the control box is in normal work.

The display area shows::

E2 means communications failure.

E16 means the temperature probe is broken circuit.

E17 means the temperature probe is short circuit.

Technical parameters:

Rated Working condition and characteristic				
Rated voltage	AC220	Frequency	50Hz	
Rated current	30A	Rated power	3.5KW	
Insulation resistance	>20MΩ	Waterproof	IP65	
Load parameters				
Loads	Rated voltage	Frequency	Rated power	Other
Thermostat	AC220V	50Hz	2KW	-
Water Pump	AC220V	50Hz	2HP	-
Air Pump	AC220V	50Hz	800W	-
Light	DC12V	-	5W	-
Ozone	DC12V	-	6W	-
Speaker	-	-	8Ohm 10w	-
USB		-		-

Fitting parameters

Control panel				
Rated voltage	Rated power	Standby power	Waterproof	Communication

Size	
Control panel	
Control box	

Installation wiring diagram

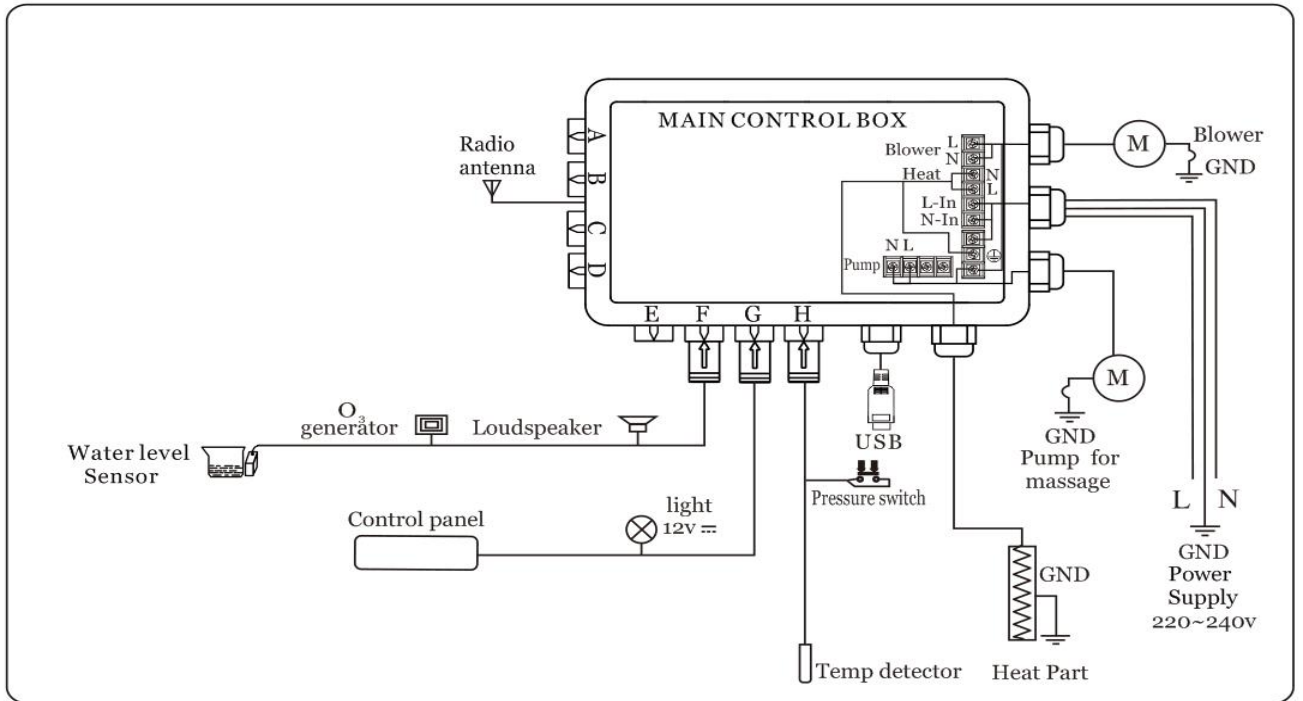

Size of Control Box

